



POWERING INNOVATION THAT DRIVES HUMAN ADVANCEMENT

© 2025 ANSYS, Inc. or its affiliated companies
Unauthorized use, distribution, or duplication is prohibited.

Getting Started with HFSS™: Bow Tie Antenna



ANSYS, Inc.
Southpointe
2600 Ansys Drive
Canonsburg, PA 15317
ansysinfo@ansys.com
<https://www.ansys.com>
(T) 724-746-3304
(F) 724-514-9494

Release 2025 R1
January 2025

ANSYS, Inc. and ANSYS
Europe, Ltd. are UL registered
ISO 9001:2015 companies.

Copyright and Trademark Information

© 1986-2025 ANSYS, Inc. Unauthorized use, distribution or duplication is prohibited.

ANSYS, Ansys Workbench, AUTODYN, CFX, FLUENT and any and all ANSYS, Inc. brand, product, service and feature names, logos and slogans are registered trademarks or trademarks of ANSYS, Inc. or its subsidiaries located in the United States or other countries. ICFM CFD is a trademark used by ANSYS, Inc. under license. All other brand, product, service and feature names or trademarks are the property of their respective owners. FLEXIm and FLEXnet are trademarks of Flexera Software LLC.

Disclaimer Notice

THIS ANSYS SOFTWARE PRODUCT AND PROGRAM DOCUMENTATION INCLUDE TRADE SECRETS AND ARE CONFIDENTIAL AND PROPRIETARY PRODUCTS OF ANSYS, INC., ITS SUBSIDIARIES, OR LICENSORS. The software products and documentation are furnished by ANSYS, Inc., its subsidiaries, or affiliates under a software license agreement that contains provisions concerning non-disclosure, copying, length and nature of use, compliance with exporting laws, warranties, disclaimers, limitations of liability, and remedies, and other provisions. The software products and documentation may be used, disclosed, transferred, or copied only in accordance with the terms and conditions of that software license agreement.

ANSYS, Inc. and ANSYS Europe, Ltd. are UL registered ISO 9001: 2015 companies.

U.S. Government Rights

For U.S. Government users, except as specifically granted by the ANSYS, Inc. software license agreement, the use, duplication, or disclosure by the United States Government is subject to restrictions stated in the ANSYS, Inc. software license agreement and FAR 12.212 (for non-DOD licenses).

Third-Party Software

See the legal information in the product help files for the complete Legal Notice for Ansys proprietary software and third-party software. If you are unable to access the Legal Notice, please contact ANSYS, Inc.

Conventions Used in this Guide

Please take a moment to review how instructions and other useful information are presented in this documentation.

- Procedures are presented as numbered lists. A single bullet indicates that the procedure has only one step.
- Bold type is used for the following:
 - Keyboard entries that should be typed in their entirety exactly as shown. For example, “**copy file1**” means you must type the word **copy**, then type a space, and then type **file1**.
 - On-screen prompts and messages, names of options and text boxes, and menu commands. Menu commands are often separated by greater than signs (>). For example, “click **HFSS > Excitations > Assign > Wave Port.**”
 - Labeled keys on the computer keyboard. For example, “Press **Enter**” means to press the key labeled **Enter**.
- Italic type is used for the following:
 - Emphasis.
 - The titles of publications.
 - Keyboard entries when a name or a variable must be typed in place of the words in italics. For example, “**copy filename**” means you must type the word **copy**, then type a space, and then type the name of the file.
- The plus sign (+) is used between keyboard keys to indicate that you should press the keys at the same time. For example, “Press Shift+F1” means to press the **Shift** key and, while holding it down, press the **F1** key also. You should always depress the modifier key or keys first (for example, Shift, Ctrl, Alt, or Ctrl+Shift), continue to hold it/them down, and then press the last key in the instruction.

Accessing Commands: *Ribbons*, *menu bars*, and *shortcut menus* are three methods that can be used to see what commands are available in the application.

- The *Ribbon* occupies the rectangular area at the top of the application window and contains multiple tabs. Each tab has relevant commands that are organized, grouped, and labeled. An example of a typical user interaction is as follows:

"Click **Draw > Line**"



This instruction means that you should click the **Line** command on the **Draw** ribbon tab. An image of the command icon, or a partial view of the ribbon, is often included with the instruction.

- The *menu bar* (located above the ribbon) is a group of the main commands of an application arranged by category such File, Edit, View, Project, etc. An example of a typical user interaction is as follows:

"On the **File** menu, click the **Open Examples** command" means you can click the **File** menu and then click **Open Examples** to launch the dialog box.

- Another alternative is to use the *shortcut menu* that appears when you click the right-mouse button. An example of a typical user interaction is as follows:

"Right-click and select **Assign Excitation > Wave Port**" means when you click the right-mouse button with an object face selected, you can execute the excitation commands from the shortcut menu (and the corresponding sub-menus).

Getting Help: Ansys Technical Support

For information about Ansys Technical Support, go to the Ansys corporate Support website, <http://www.ansys.com/Support>. You can also contact your Ansys account manager in order to obtain this information.

All Ansys software files are ASCII text and can be sent conveniently by e-mail. When reporting difficulties, it is extremely helpful to include very specific information about what steps were taken or what stages the simulation reached, including software files as applicable. This allows more rapid and effective debugging.

Help Menu

To access help from the Help menu, click **Help** and select from the menu:

- **[product name] Help** - opens the contents of the help. This help includes the help for the product and its *Getting Started Guides*.
- **[product name] Scripting Help** - opens the contents of the *Scripting Guide*.
- **[product name] Getting Started Guides** - opens a topic that contains links to Getting Started Guides in the help system.

Context-Sensitive Help

To access help from the user interface, press **F1**. The help specific to the active product (design type) opens.

You can press **F1** while the cursor is pointing at a menu command or while a particular dialog box or dialog box tab is open. In this case, the help page associated with the command or open dialog box is displayed automatically.

Table of Contents

Table of Contents	Contents-1
1 - Overview	1-1
Initial Setup	1-1
Insert HFSS Design Type	1-2
Enable Legacy View Orientations	1-4
Set Up General Options	1-5
Modify Attributes	1-9
Define Units	1-10
Define Solution Type	1-11
2 - Parametric Method of Creating the Antenna	2-1
Create Substrate	2-1
Assign Substrate Material and Name	2-3
Section the Substrate at Its Mid-Length	2-6
Thicken the Sheet Object	2-9
Move The Thickened Object	2-11
Subtract Bow Tie from Substrate	2-14
Move Bow Tie Object in -Z Direction	2-15
Create Starting Face for Flare Object	2-16
Create the Flare Geometry	2-20
Create the Feed Inset	2-24
Create Face CS for Outer Feed Face	2-26
Creating the Port Area Object	2-28
Unite the Bow Tie Objects	2-32
Create the Ground Plane	2-35
Assign Finite Conductivity Boundary	2-36
Subtract Bowtie From GND	2-38
3 - Simulation and Results	3-1
Assign Excitations	3-1

Define Solution Frequency	3-5
Create Open Region	3-6
Parametrization and Analysis	3-8
Change the Field Inset	3-8
Validate the Simulation Setup	3-11
Run the Analysis	3-11
Define Far Field Setups	3-11
Create S Parameter Plot	3-14
Create Z Matrix Plot	3-15
Create Far Field Pattern (3D Polar Plot)	3-18
Create Radiation Pattern	3-20
Overlay Radiation Pattern	3-25
Overlay Visibility	3-27
4 - Linear Method Of Creating The Bow Tie Antenna	4-1
Initial Preparation	4-1
Draw Substrate	4-3
Create Copper Cladding	4-5
Assign Finite Conductivity to Copper Cladding	4-6
Create Feed Cut Out	4-8
Create Bow Tie Arm	4-10
Mirror the Feed and Bow Tie Objects	4-12
Unite Feed and Bow Tie Objects	4-14
Open the Bow Tie Aperture in the Copper Cladding	4-15
Excite the Antenna with a Lumped Port	4-16
Create Analysis Setup and Frequency Sweep	4-21
Create Radiation Setup	4-22
Validate and Analyze the Design	4-24
Generate Reports	4-24
5 - Antenna Design Toolkit	5-1
ACT Extensions	5-1

6 - Optionally, Restore Current View Orientations	6-1
--	------------

1 - Overview

Bow Tie Antenna

Different Ways to Create the HFSS Model

1. Parametric Design

2. Linear Approach

3. Antenna Design
Toolkit

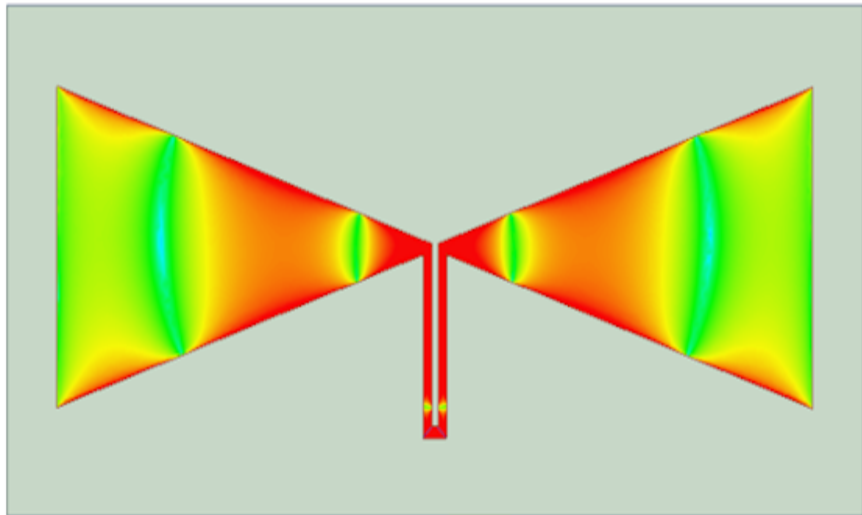

This Getting Started Guide contains three separate tutorials that show you how to create a coplanar, waveguide-fed, bow tie antenna in Ansys HFSS. There are multiple ways to create and solve designs in HFSS. A bow tie antenna is a simple design that can be created using any of the following methods:

- **Parametric Method:** Makes use of advanced 3D Modeler commands.
- **Linear Method:** The traditional approach of creating the antenna in a "linear" fashion.
- **Antenna Design Toolkit:** Automatically generates the antenna in a ready-to-solve state.

The first tutorial covers the parametric method, the second one covers the "linear" method, and the third one covers the automatic method of creating the antenna.

Initial Setup

In the subsections that follow, you will perform the following tasks:

- Launch Ansys Electronics Desktop and insert an HFSS design into your project
- Set up general options

- Modify some program attributes (background color and grid visibility)
- Define the length unit
- Define the solution type

Insert HFSS Design Type

Add an HFSS design type into your project in the Electronics Desktop as follows.



1. Launch Ansys Electronics Desktop.
2. In a new project does not already exist at the top of the Project Manager, press **CTRL + N** to create one.
3. Select the project folder, press **F2**, and rename the project to **Parametric Bow Tie Antenna**.

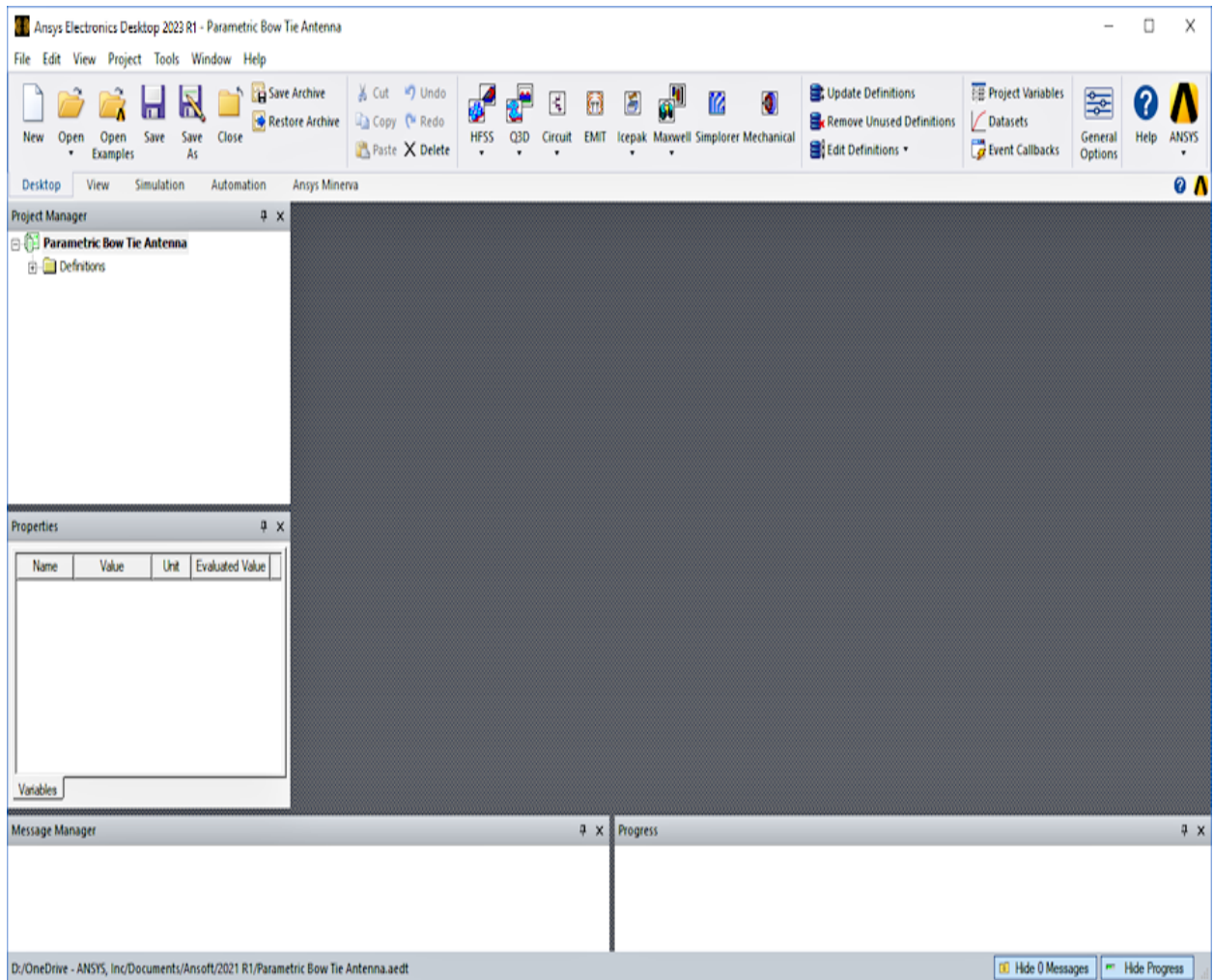

4. From the **Project** menu, select the first option, **Insert HFSS Design**.

Note:

Alternatively, you can click  **Insert HFSS Design** from the **Desktop** ribbon tab.

This command inserts the HFSS design type into your project. The first such design added to your project is named *HFSSDesign1* by default.

Enable Legacy View Orientations

This getting started guide was created based on standard view orientations that were in effect for version 2023 R2 and earlier of the Ansys Electronics Desktop application. For consistency between your experience and the views and instructions contained in this guide, select the *Enable Legacy View Orientation* option in the 3D UI Options dialog box, as follows:

1. From the menu bar, click **View > Options**.

The *3D UI Options* dialog box appears.

2. Select **Enable Legacy View Orientation**:

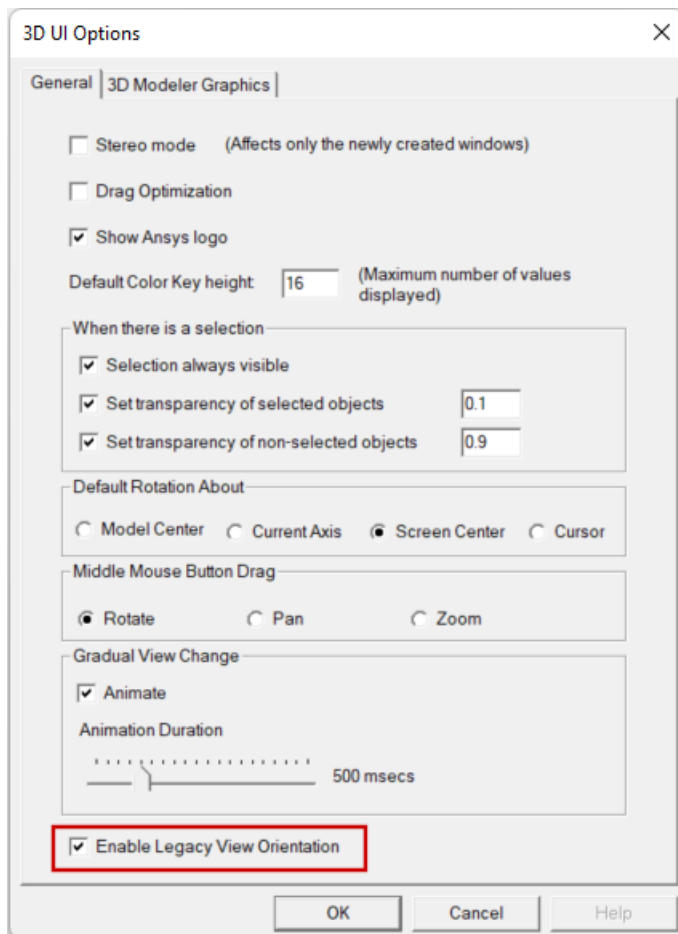

3. Click **OK**.

Changing the view orientation option does not change the model viewpoint that was in effect at the time.

4. On the **Draw** ribbon tab, click **Orient** to change to the *Trimetric* view, which is the default legacy view orientation.

You do not have to select *Trimetric* from the *Orient* drop-down menu. The default view appears when you click *Orient*.

Although this option can only be accessed once a design is added to a project, it is a global option. Your choice is retained for all future program sessions, projects, and design types that use the 3D Modeler or that produce 3D plots of results.

At the end of this guide, you will be prompted to clear the *Enable Legacy View Orientation* option, if you prefer to use the view orientation scheme implemented for 2024 R1 and newer versions going forward.

For a comparison of the legacy and current view orientations, search for "*View Options: 3D UI Options*" in the HFSS help. Additionally, views associated with **Alt + double-click** zones have been redefined. The current orientations are shown in the help topic, "*Changing the Model View with Alt+Double-Click Areas*."

Set Up General Options

Before you begin working in HFSS, define some preliminary settings in the *Options* dialog.

1. Open the *Options* dialog from **Tools > Options > General Options**.
2. In the *Options* tree, expand **General** and click **User Interface**. Then, select the **Color scheme** of your choice from the drop-down menu.

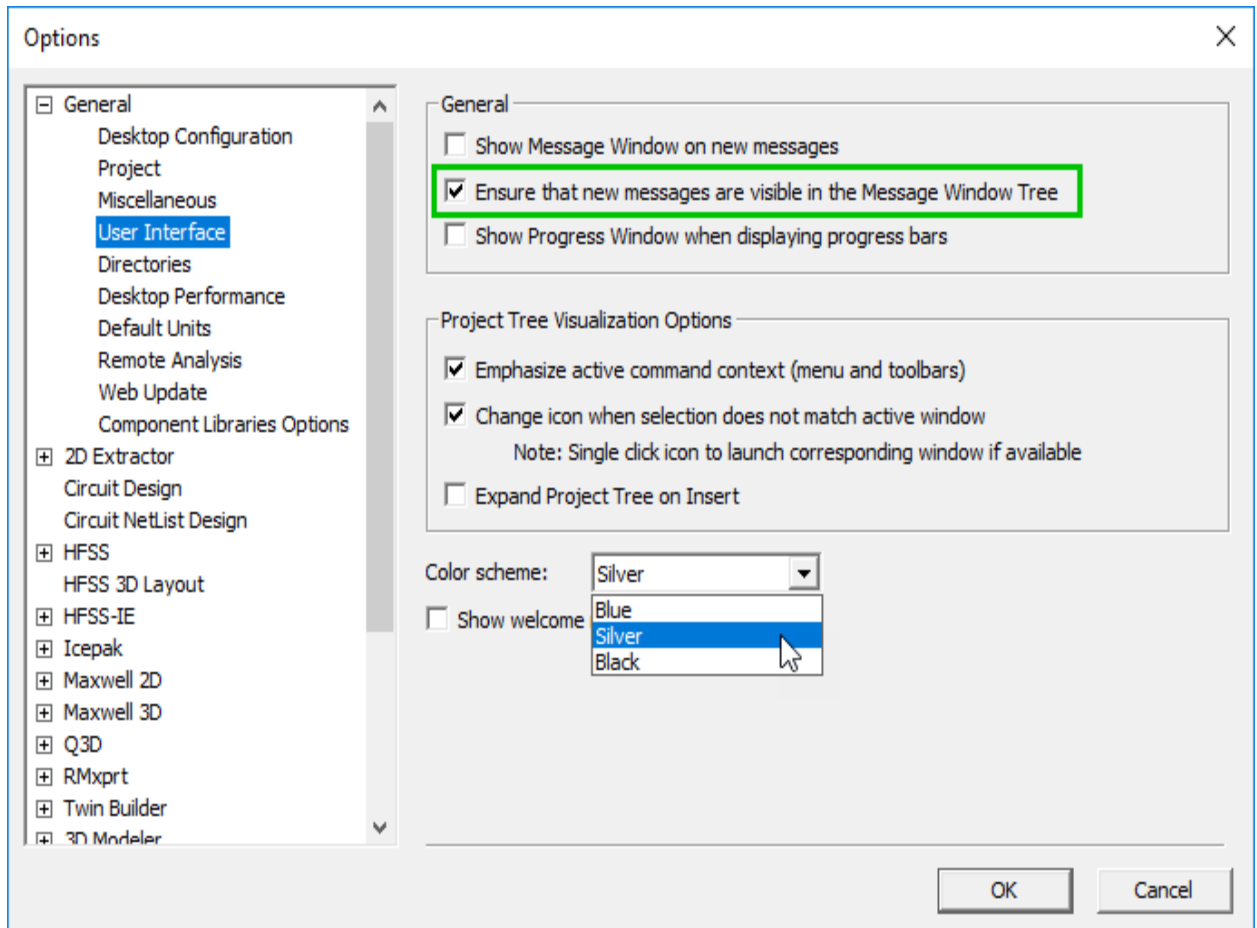

3. Verify that the option, **Ensure that new messages are visible in the Message Window Tree**, is selected.
4. Expand **HFSS** and click **Boundary Assignment**. Then, ensure that the **Duplicate boundaries/mesh operations with geometry** option is selected.

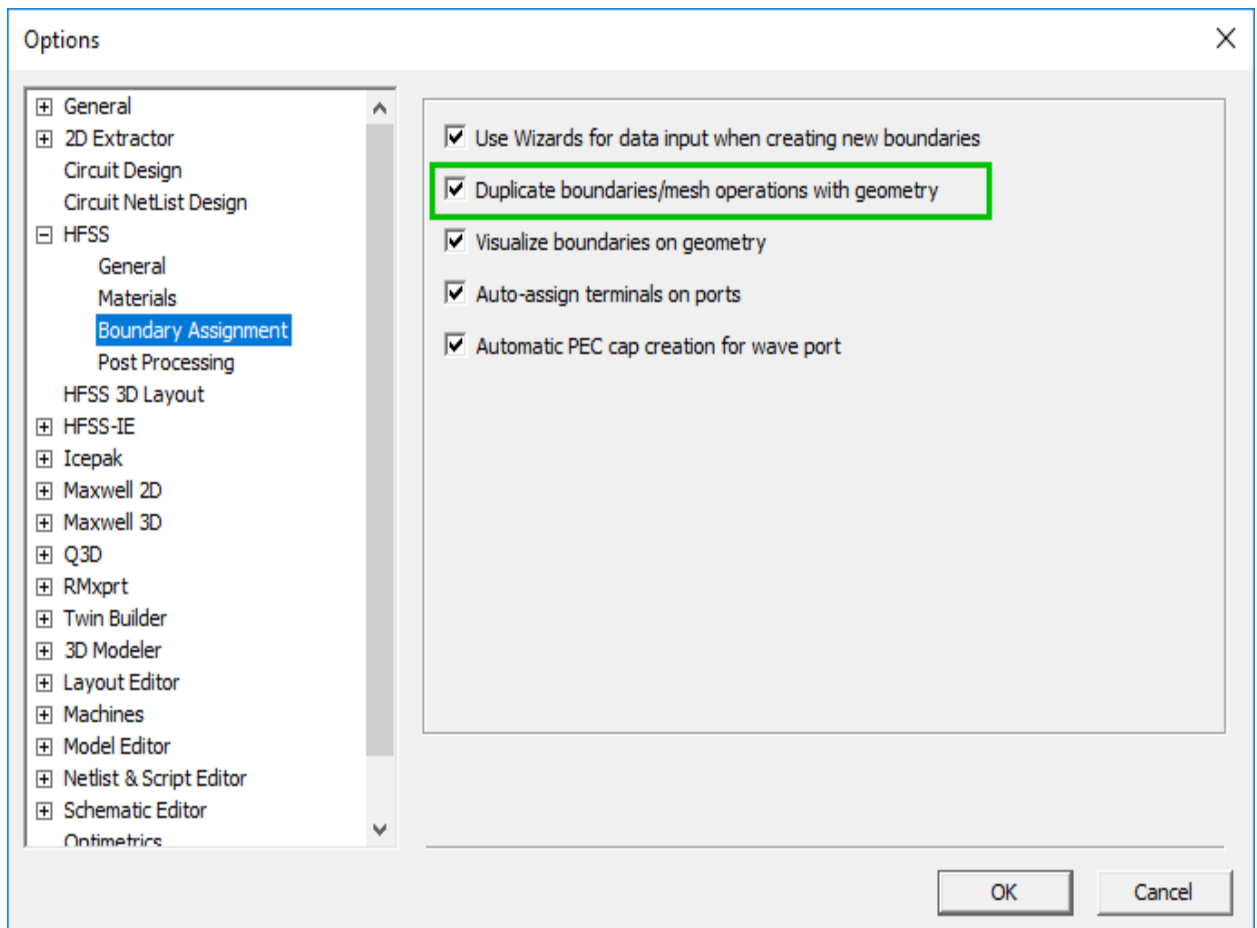
**Note:**

This option causes all boundaries and excitations to be duplicated with their associated geometries.

5. Expand **3D Modeler** and click **Drawing**. Ensure that the **Edit properties of new primitives** option is selected.

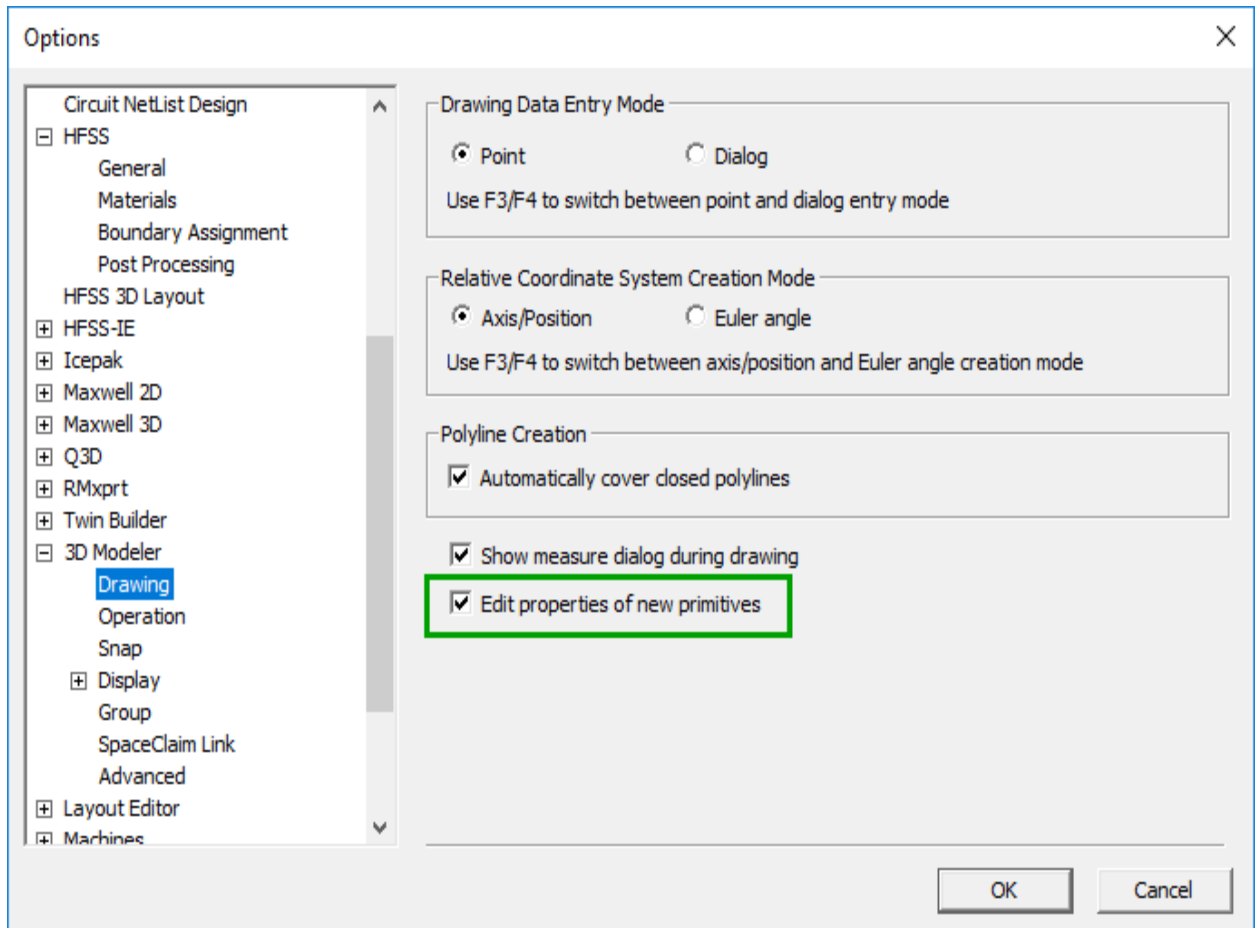

Note:

This option automatically opens the Properties dialog box when a new object is drawn, allowing you to immediately edit the command parameters (location, dimensions, and so on) and the attributes (name, material, color, and transparency)

6. Go to **3D Modeler > Display > Rendering** in the *Options* tree and ensure that **Use material appearance if available** is selected.

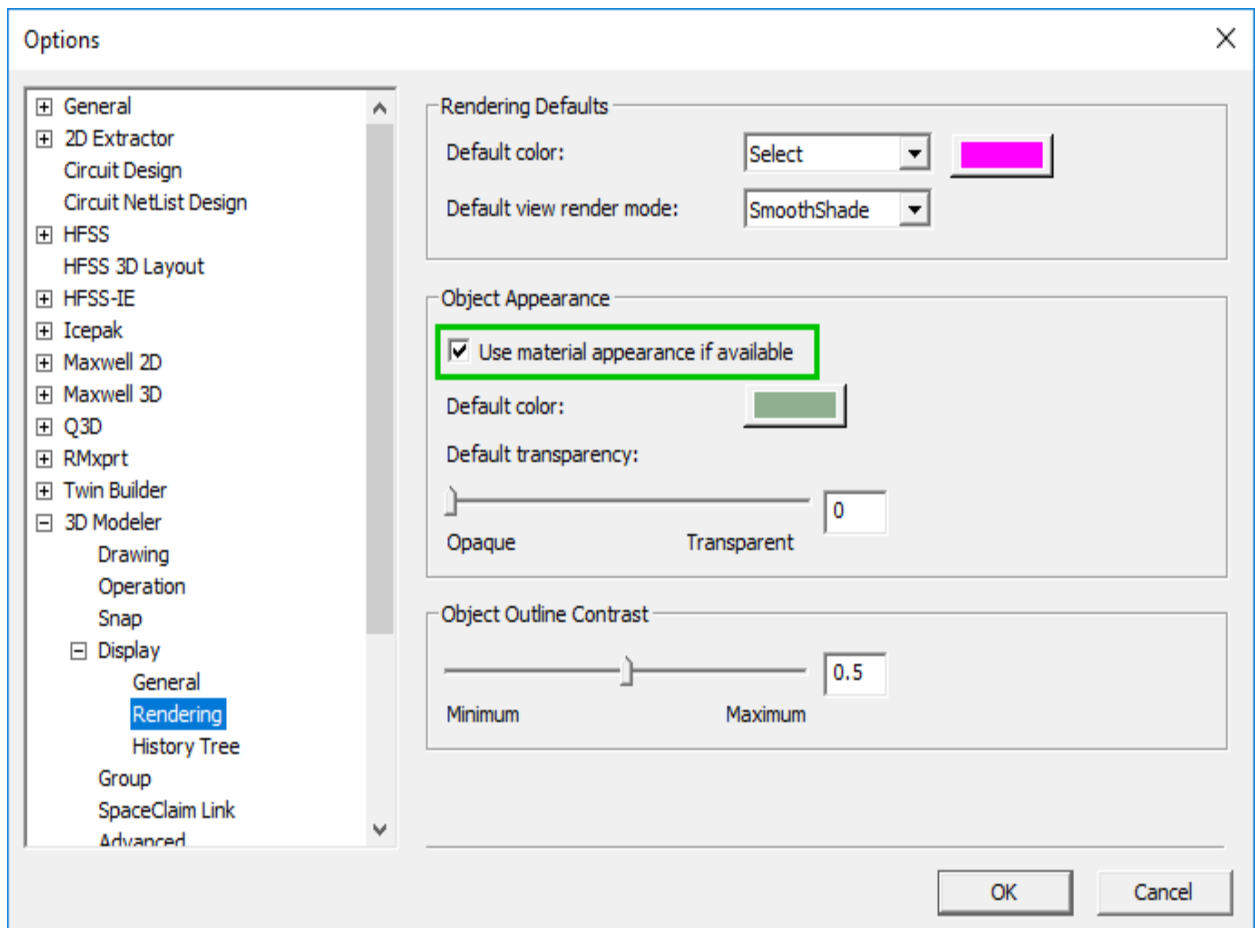
**Note:**

This option applies the appearance specifications from the materials library when they are available (color and transparency). You will be applying library materials to objects in the Bow Tie Antenna model. This option ensures that your model appearance with match the images in this *Getting Started Guide*.

7. Click **OK** to close the *Options* dialog box.

Modify Attributes

You can leave the background color as white which is the default. If you want to change the background to a color of your choosing, perform the following steps:

1. Go to **View > Modify Attributes > Background Color**.
2. In the *Select Background Color* dialog box, pick either a **Gradient** or a **Solid** background and assign colors as you wish.

Note:

If you choose **Gradient Background**, click the **Top Color** and the **Bottom Color** buttons and select the desired colors.

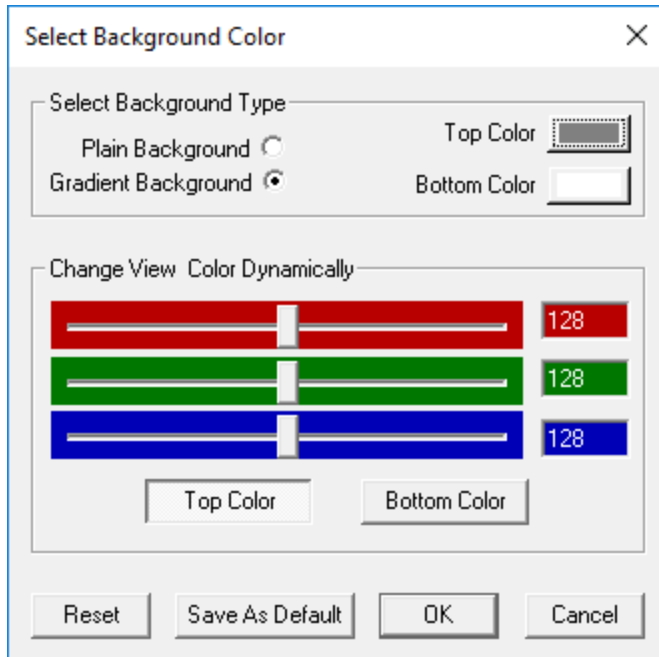

The images in this Getting Started Guide were captured using a plain white background.

3. Optionally, to hide the grid, use the menu bar and click **View > Grid Settings**. Then, in the *Grid Spacing* dialog box, select **Hide** under *Grid visibility*.

Define Units

Define the units of measurement for drawing the geometric models as follows:

1. From the menu bar, click **Modeler > Units**.

The *Set Model Units and Max Extent* dialog box appears.

2. Ensure that **mm** is selected from the **Select units** drop-down menu.

Keep the **Rescale to new units** and **Advanced** options cleared.

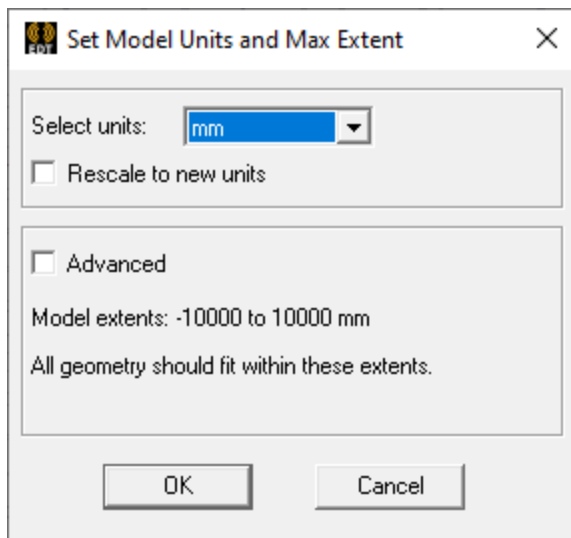

3. Click **OK**.

Define Solution Type

Specify the type of solution you want HFSS to calculate for your design. For this problem, use an HFSS modal solution type, where the S-matrix solutions are expressed in terms of incident and reflected powers of transmission line modes.

1. From the menu bar, click **HFSS > Solution Type**.

The *Solution Type* dialog box appears.

2. Under **Options**, select **Modal** and also ensure that the remaining settings are as shown in the following image:

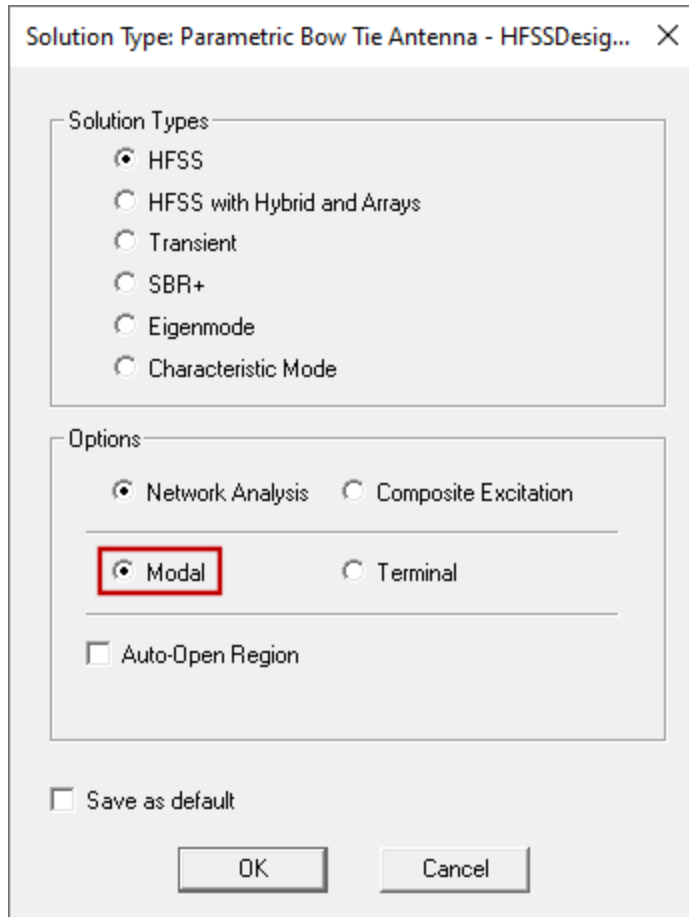

3. Click **OK**.

2 - Parametric Method of Creating the Antenna

This tutorial describes a parametric method of designing a bow tie antenna in Ansys HFSS by leveraging features of the 3D Modeler. This method helps you efficiently manage different modeler commands and treat the History Tree as a "programming language." Creating the antenna geometry parametrically instead of using a "linear" approach exposes some interesting features in HFSS. Some of the modeler commands used in this tutorial include **Snap**, **Sweep Along Vector**, **Split**, **Padding**, **Move**, **Move Faces Along Normal**, and **Create Object From Face**.

You will learn how to:

- Create objects that make up the antenna
- Parametrize these objects
- Take advantage of the features of the 3D Modeler
- Assign boundary conditions
- Assign excitations
- Define the Solution Setup and run the simulation
- Perform post processing (plot and evaluate results)

This chapter describes how to create the following objects:

- Substrate
- Bowtie

When creating the antenna, take advantage of the History Tree and use parametrization (variables) for defining object properties.

Create Substrate

Draw the substrate using the *Box* primitive command and then parametrize it as follows:

1. From the **Draw** ribbon tab, click  **Draw box**.
2. Press **F3** to ensure that you are in the graphical input mode.
3. Click anywhere in the *Modeler* window, move the mouse, and click a second time to create the base.
4. Move the mouse upward and click a third time to define the height.

These operations create a box of random size. Immediately after the third click, the *Properties* dialog box opens automatically (due to the setting defined in [Step 5 of the Set Up General Options](#) page). The next step is to parametrize the box by replacing absolute coordinates and dimensions in the *Properties* dialog box with variables.

5. In the **Command** tab of the *Properties* dialog box, enter variables with meaningful names for the substrate box's position, size, and thickness. Specify the following variable names for the **Position**, **XSize**, **YSize**, and **ZSize** values:

- a. *Position*: **-SubSizeX/2, -SubSizeY/2, -SubThickness**
- b. *XSize*: **SubSizeX**
- c. *YSize*: **SubSizeY**
- d. *ZSize*: **SubThickness**

where

- *SubSizeX* = 34 mm
- *SubSizeY* = 64 mm
- *SubThickness* = 2 mm

Note:

When you press **Enter** after specifying one or more new variable names, the software automatically opens an *Add Variable* dialog box for you to assign a value for each variable. You do not need to define the *Unit Type* and *Unit* parameters if you include "**mm**" with your numeric dimensions (such as *34mm*).

Double-check your edited fields for the substrate in the **Command** tab of the *Properties* dialog box. They should be exactly as shown in the following figure:

Command		Attribute		
	Name	Value	Unit	Evaluated Value
	Command	CreateBox		
	Coordinate Sys...	Global		
	Position	-SubSizeX/2 , -SubSizeY/2 , -SubThickness		-17mm , -32mm , -2mm
	XSize	SubSizeX		34mm
	YSize	SubSizeY		64mm
	ZSize	SubThickness		2mm

The specified dimensions and coordinates place the centroid of the top face at the global origin.

6. Do *not* close the *Properties* dialog box yet. In the next procedure, you will modify the object attributes (name and material).

Note:

Rather than first drawing a random box and then modifying its parameters in the *Properties* dialog box, you can use one of the following two alternative techniques for specifying the parameters:

- While in graphical input mode (**F3**), use the **X**, **Y**, **Z**, **dX**, **dY**, and/or **dZ** text boxes along the bottom of the Ansys Electronics Desktop window to type in the exact coordinates and dimensions of the primitive object. Be careful not to move the mouse while typing the numbers or the cursor location will supersede the entered values.
- Press **F4** immediately after clicking **Draw Box** or another drawing command. The *Properties* dialog box opens, and you can numerically specify the object parameters without first graphically defining a random object. As with the previous technique, both the *Command* and the *Attribute* tabs are available in the *Properties* dialog box. This behavior continues for subsequent objects you create. Pressing **F3** after clicking a *Draw* command, restores the graphical specification method.

Tip:

- In the History Tree, double-clicking the name of an object you previously created (such as *Box1*) opens the *Properties* dialog box, but only the *Attribute* tab is available. From there, you can modify the name, material, color, and transparency, along with a few more attributes. The same attributes are available for editing within the docked *Properties* window when you select an object entry in the History Tree.
- Double-clicking a *draw-primitive* entry in the History Tree (such as *CreateBox*) also opens the *Properties* dialog box. However, in this case, only the *Command* tab is available. From there, you can modify the geometry of the primitive (location coordinates, dimensions, and coordinate system). The same command parameters are available in the docked *Properties* window when you select a draw-primitive entry in the History Tree.

Assign Substrate Material and Name

The *Properties* dialog box should still be open from the previous procedure. Assign a material and name for the substrate as follows:

1. Select the **Attributes** tab of the *Properties* dialog box.
2. From the **Materials** drop-down menu, click **Edit**.

The *Select Definition* window appears.

3. Ensure that the **Select all libraries** option is selected to display all materials.
4. Type **Arlon** in the **Search** field to quickly locate the beginning of the Arlon variants. Then, scroll down in the materials list, select **Arlon CuClad 217 (tm)**, and click **OK** to close the *Select Definition* dialog box. Leave the *Properties* dialog box open.

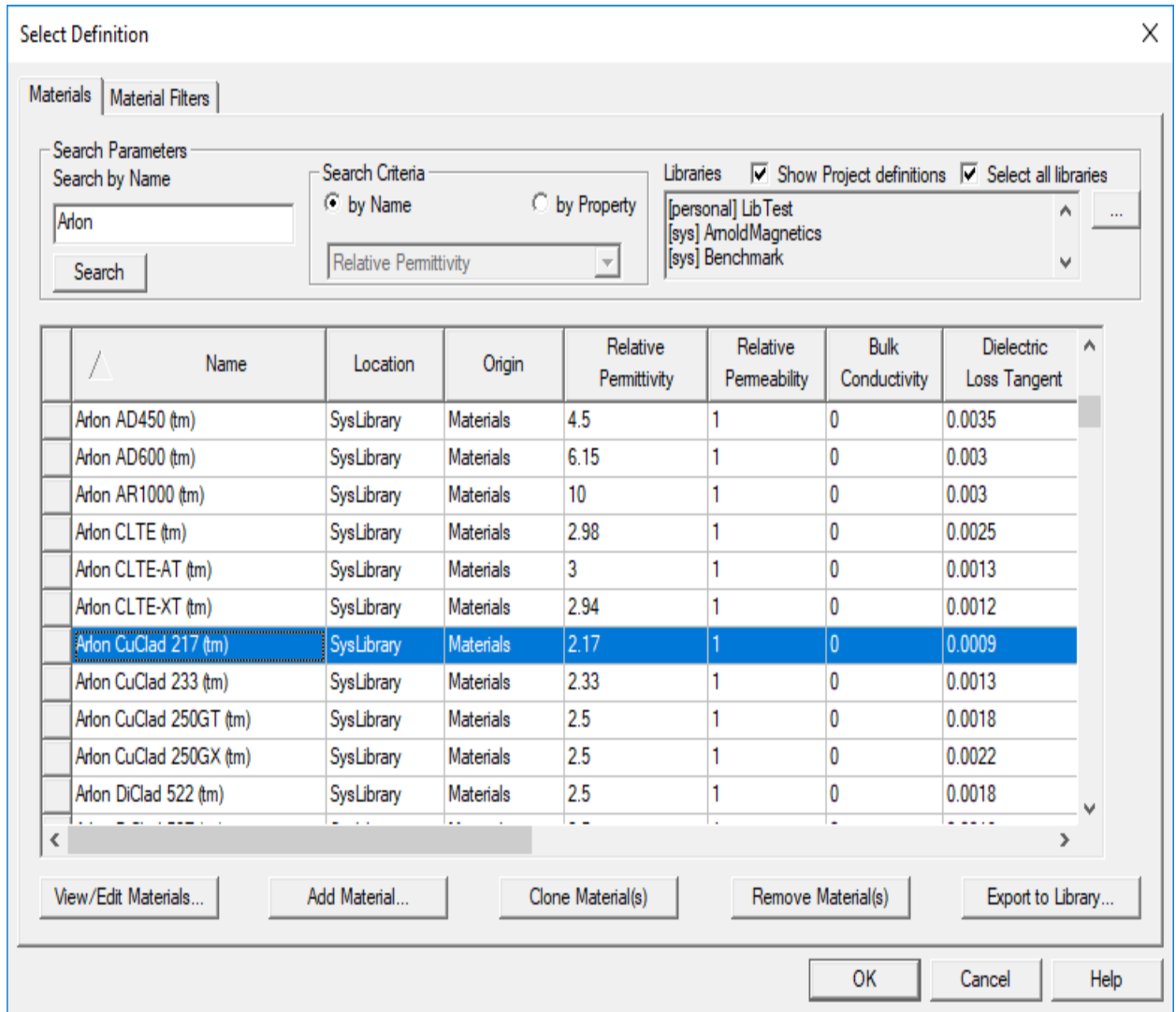

5. Change the **Name** to **Substrate**.

Command		Attribute		
Name	Value	Unit	Evaluated Value	
Name	Substrate			
Material	"Arlon CuClad 217 (tm)"		"Arlon CuClad 217 (tm)"	
Solve Inside	<input checked="" type="checkbox"/>			
Orientation	Global			
Model	<input checked="" type="checkbox"/>			
Group	Model			
Display Wirefra...	<input type="checkbox"/>			
Material Appea...	<input checked="" type="checkbox"/>			
Color	<input type="text" value=""/>			
Transparent	<input type="text" value="0"/>			

Note:

The *Color* sample will not reflect the Arlon CuClad 217 (tm) material's color assignment until you click OK to apply the attributes and later revisit the object properties. Despite the light gray color shown in the dialog box, the actual material color of dark green is assigned to the object as soon as you click OK and clear the selection to remove the magenta highlighting.

- Click **OK** to close the *Properties* dialog box.
- In the **Draw** ribbon tab, click  **Fit All** to fit the substrate to the Modeler window's display area.

Note:

Alternatively, you can press **Ctrl + D** to fit the model to the display area.

- Click in the Modeler window's background area to deselect the substrate. The color and transparency are set according to the appearance data for the selected library material:

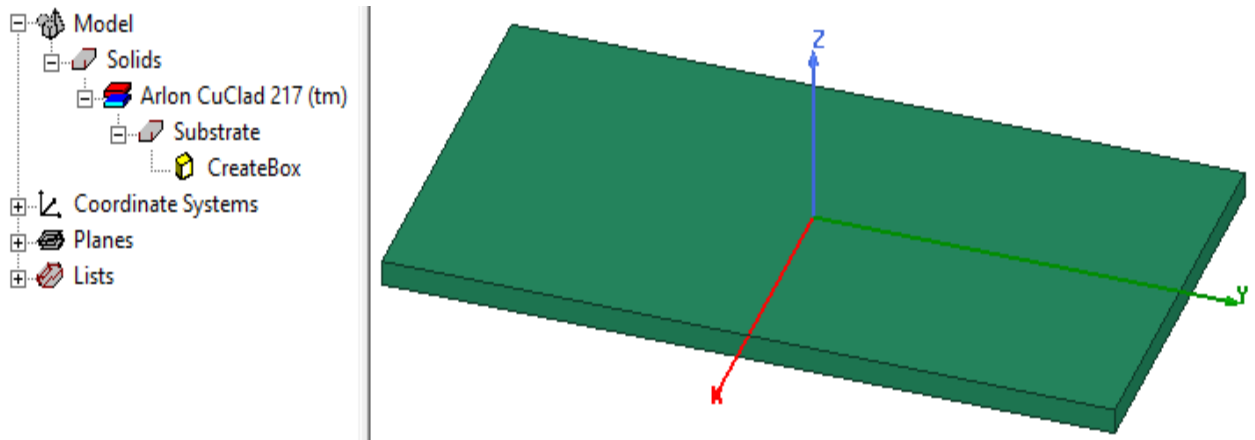

Section the Substrate at Its Mid-Length

In this tutorial all modeler commands are used in such a way that the objects become intrinsically related to one another. As you use the modeler tricks to create the geometry, you will appreciate the virtue of intrinsic parametrization.

This section describes how to utilize the existing cross-section of the substrate and easily create a 2D sheet object from it. You can perform this operation at the center of the substrate's length by using the **Section** command along a chosen plane (in this case, the **XZ** plane). Following this operation, you can use the **Split** command to split the 2D sheet object along the YZ plane. These are preliminary operations you need to perform to eventually create what will become the feed object.

The required steps are listed below.

1. Click anywhere in the background of the *Modeler* window canvas and press **O** to ensure that you are in the **Object** selection mode.
2. Select the substrate.
3. In the **Draw** ribbon tab, choose **Section** from the **Surface** drop-down menu.

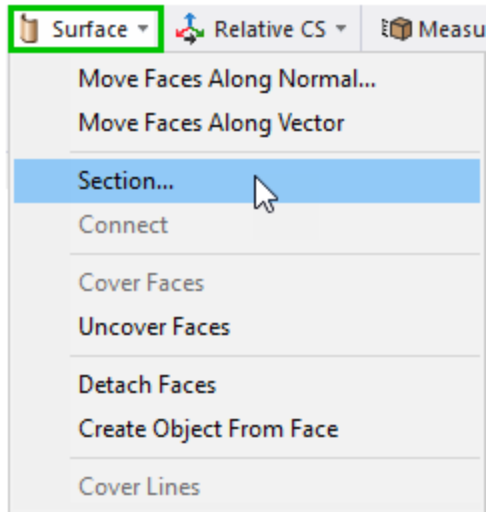

4. Select **XZ** as the **Section Plane**.

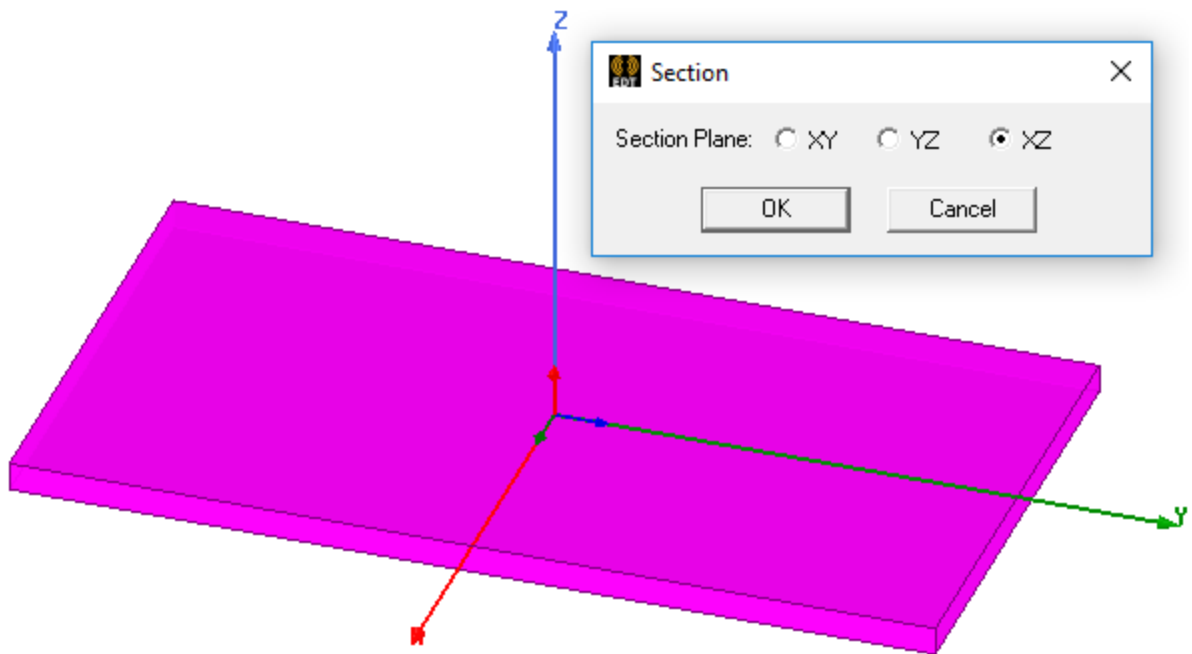

5. Click **OK**.

This command creates a sheet object corresponding to the intersection of the substrate and XZ plane, as shown below. The substrate is not divided but remains a single object.

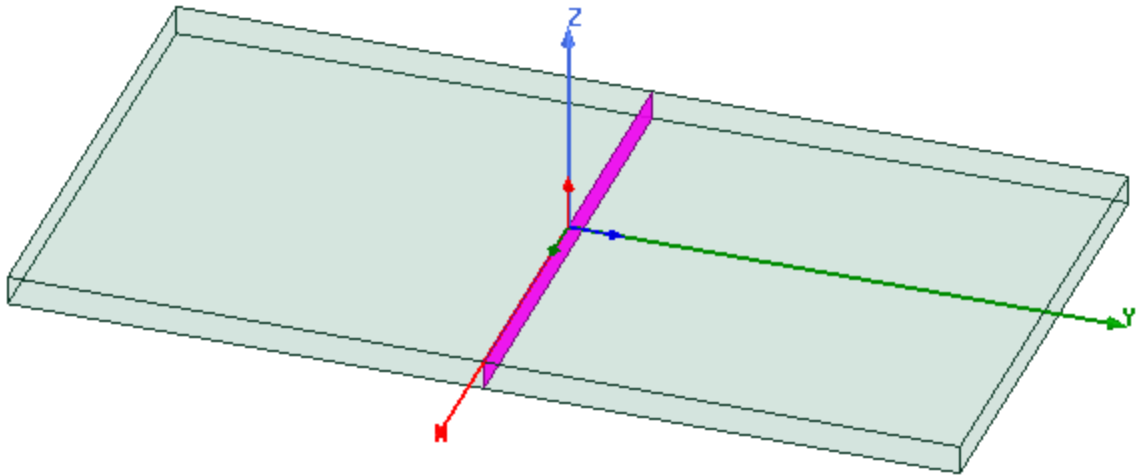

Note:

The sheet object should be currently selected. If not, click to select it. The substrate is shown transparently while the sheet object is selected.

- From the **Draw** ribbon tab, click  **Split**.

The *Split* dialog box appears.



- Select **YZ** from the **Split using plane** drop-down menu.

Note:

Ensure that the settings on the *Split* dialog box are as shown in the preceding figure. Also, the operation preview should look like the following figure.

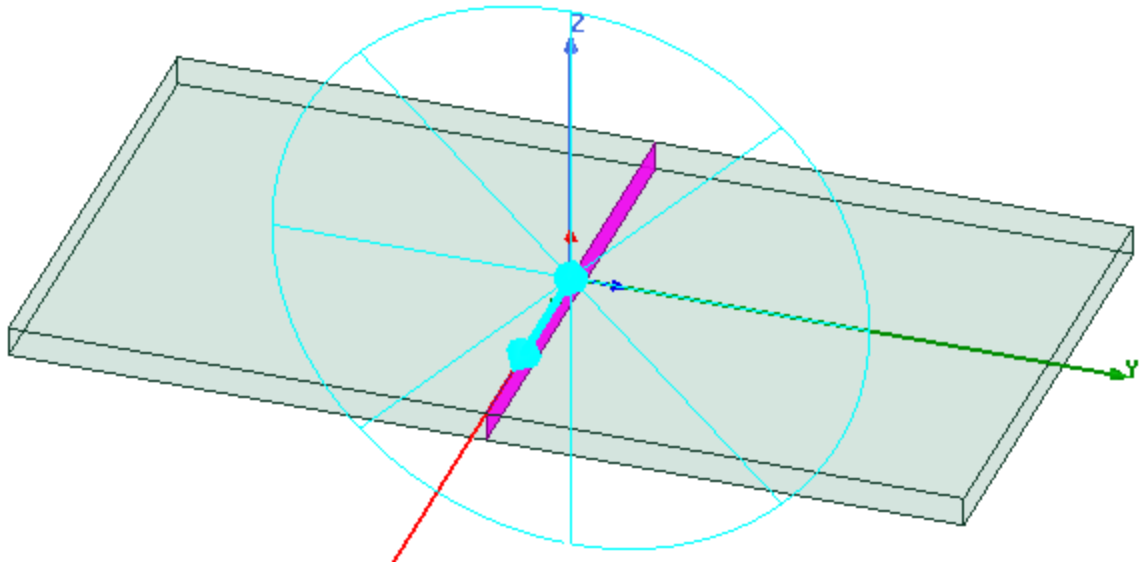

8. Click **OK**.

This operation splits the sheet and retains the fragment on the positive side of the X axis.

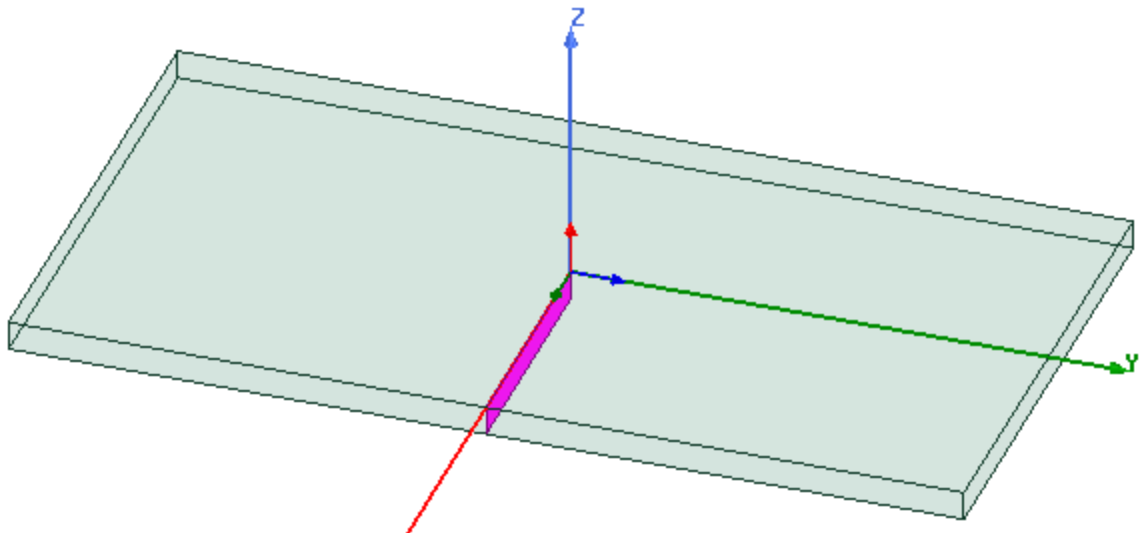

Thicken the Sheet Object

Using the sheet object just created, thicken it into a solid to create what will eventually become the feed for the bow tie antenna.

1. If it is not still selected, reselect the sheet object that remains after applying the *Section* and *Split* operations.
2. From the **Draw** ribbon tab, choose **Thicken Sheet** from the **Surface** drop-down menu.

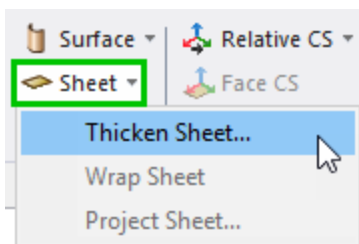

The *Thicken Sheet* dialog box appears.

3. Select the **Both Sides** option.
4. Create a variable for the thickness called **FeedWidth** and assign a value of **0.6 mm**.

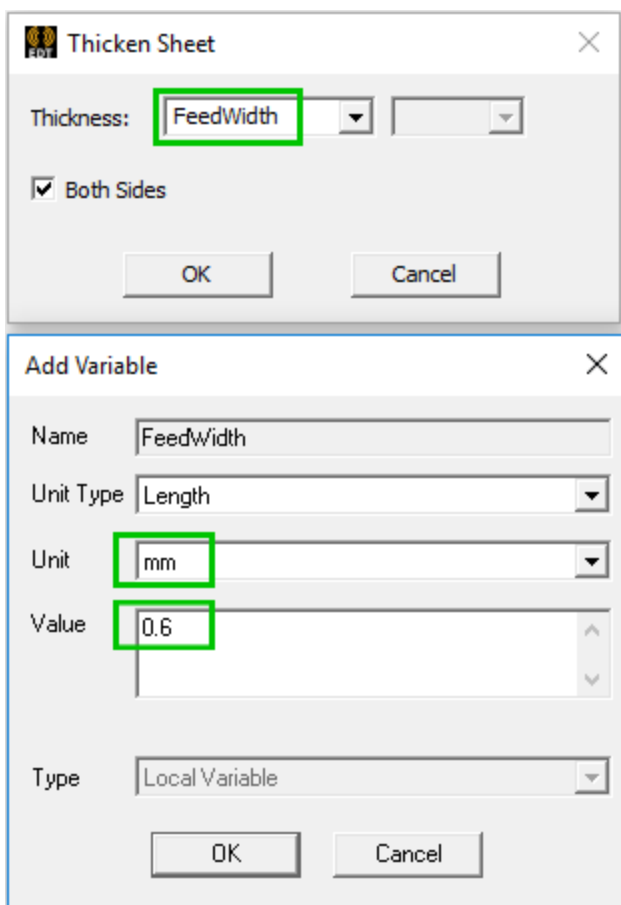

5. Click **OK** on the *Add Variable* and *Thicken Sheet* dialog boxes.

The sheet object has been converted to a solid object with the specified thickness.:

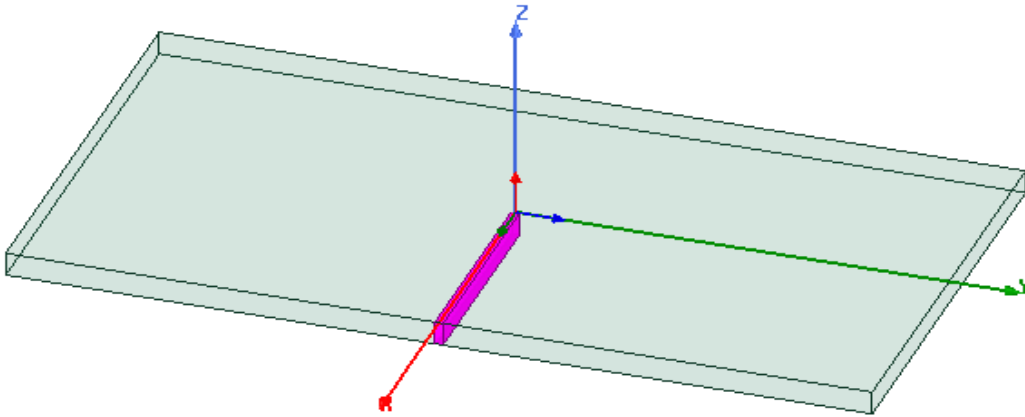
**Note:**

Due to the selection of the *Both Sides* option, the sheet was thickened +/- 0.3 mm (symmetrically about the original sheet object's plane). If this option had not been selected, the sheet would have been thickened 0.6 mm in the positive normal direction.

Move The Thickened Object

This section describes how to move the feed object a small distance in the +Y and +Z directions:

1. In the **Object** selection mode, select the feed object (if it is not already selected).
2. From the **Draw** ribbon tab, click  **Move**.
3. Click two points on the substrate—the bottom vertex at the front-right corner followed by the top vertex at the front-right corner.

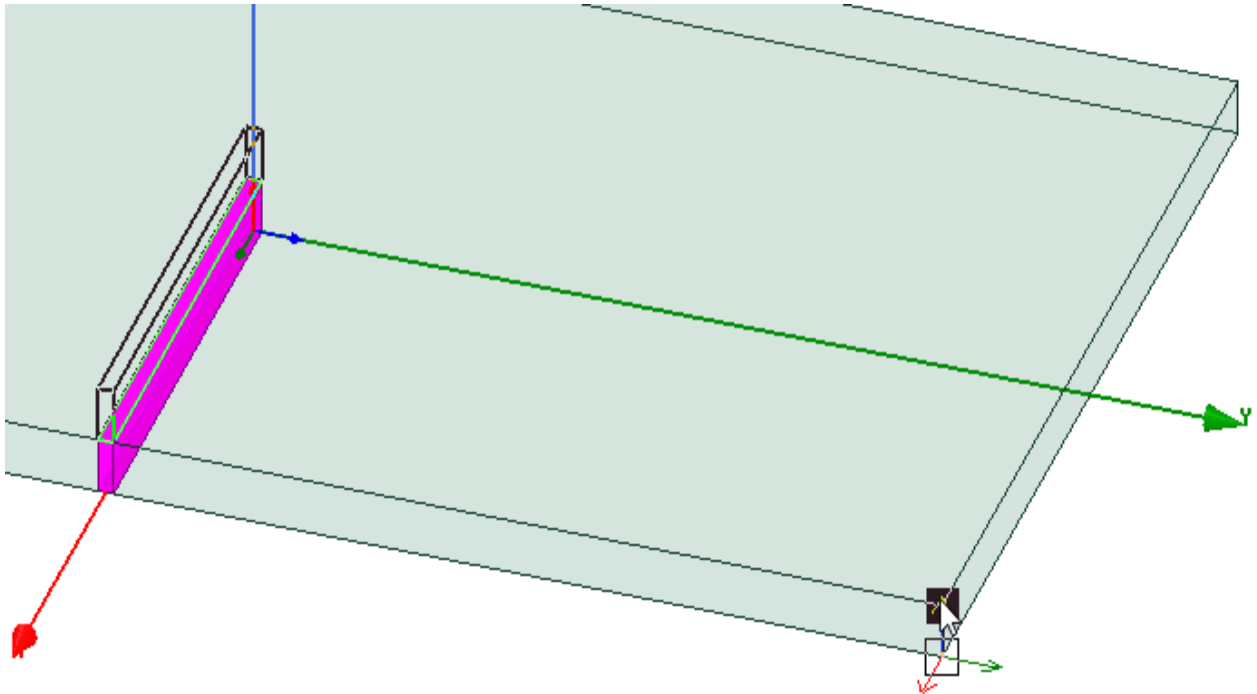

The *Properties* dialog box appears as soon as you click the second vertex.

Note:

The two points you clicked are arbitrary. You will adjust the actual move vector in the next step.

4. In the **Command** tab of the *Properties* dialog box, edit the **Move Vector**. Base the Y and Z coordinates on a new variable **Gap** and the existing variable **FeedWidth**, as shown below:
 - a. *Y Coordinate*: $\text{Gap}/2 + \text{FeedWidth}/2$. Define the value **Gap** as **1 mm**.
 - b. *Z Coordinate*: **FeedWidth**

Command		Attribute		
Name	Value	Unit	Evaluated Value	
Command	Move			
Coordinate Sys...	Global			
Move Vector	0mm , Gap/2+FeedWidth/2 , FeedWidth		0mm , 0.8mm , 0.6mm	
Suppress Com...	<input type="checkbox"/>			

Keep the *Properties* dialog box open. You will be making further changes to this object.

The *Evaluated Value* of the *Move Vector* is 0 mm, 0.8 mm, 0.6 mm. So, you are moving the object in the +Y and +Z directions.

Note:

The purpose of the Y movement is to place the feed in its final horizontal position, forming a gap of 1 mm between it and its mirrored counterpart, which will be created in a future procedure. (The left face of this part is placed 0.5 mm to the right of the substrate centerline, which lies along the mirror plane.) The purpose of the Z movement is to place a portion of the object's height above the substrate. Later, you will eliminate the portion of the object that overlaps the substrate, trimming the feed to the desired height. Finally, the Z position of the feed will be lowered to its final vertical position.

5. In the **Attribute** tab of the *Properties* dialog box, change the **Name** to **BowTie**.
6. Click in the **Value** column of the **Material** row and choose **Edit** from the drop-down menu.

The *Select Definition* dialog box appears.

7. Enter **copper** in the **Search by Name** field. The copper row is highlighted in the material list, and you can click **OK** to apply it.
8. Click **OK** to accept the attributes and close the *Properties* dialog box.
9. Click in the background area of the Modeler canvas to deselect the *BowTie* object. Your model should look like the following image:

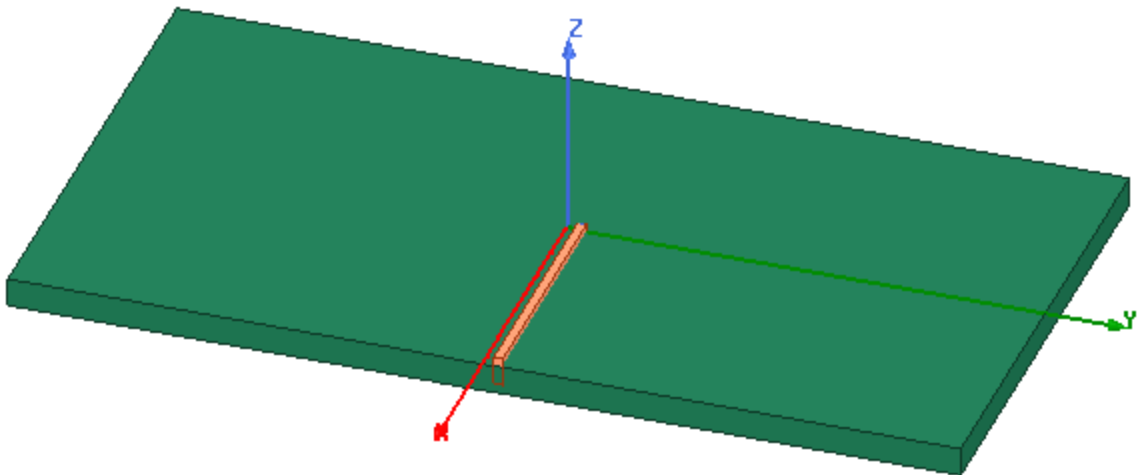

The next section shows how to perform a Boolean subtraction operation with the *BowTie* and the *Substrate* objects.

Subtract Bow Tie from Substrate

In the previous section you saw how to move the thickened object along the positive Z direction by using the **Move** command and defining a variable distance along Z. You renamed the moved object as **BowTie** and assigned copper as its material. Now you will subtract the portion of the BowTie object that overlaps the substrate.

1. In the History Tree, click **BowTie** (under *copper*) and, with the **CTRL** key held, click **Substrate** (under *Arlon*). Both items should be selected.
2. In the **Draw** ribbon tab, click  **Subtract**.

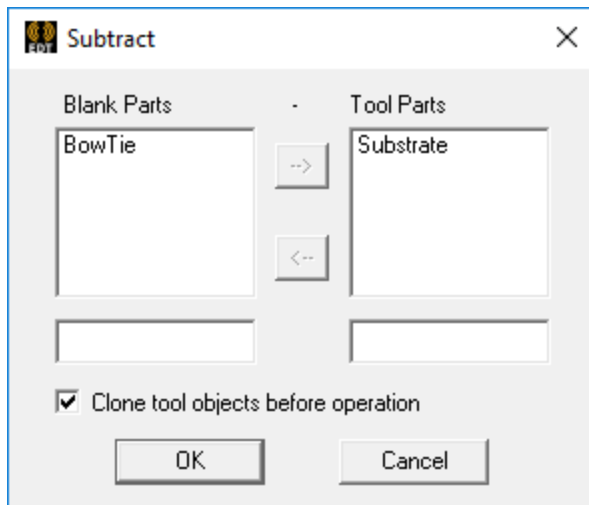

3. Select the **Clone tool objects before operation** option.
4. Ensure that *BowTie* is listed under *Blank Parts* and *Substrate* is listed under *Tool Parts*. Then, click **OK** to perform the subtraction.

Note:

The selection order of the objects determines which is the *Blank* and which is the *Tool*.

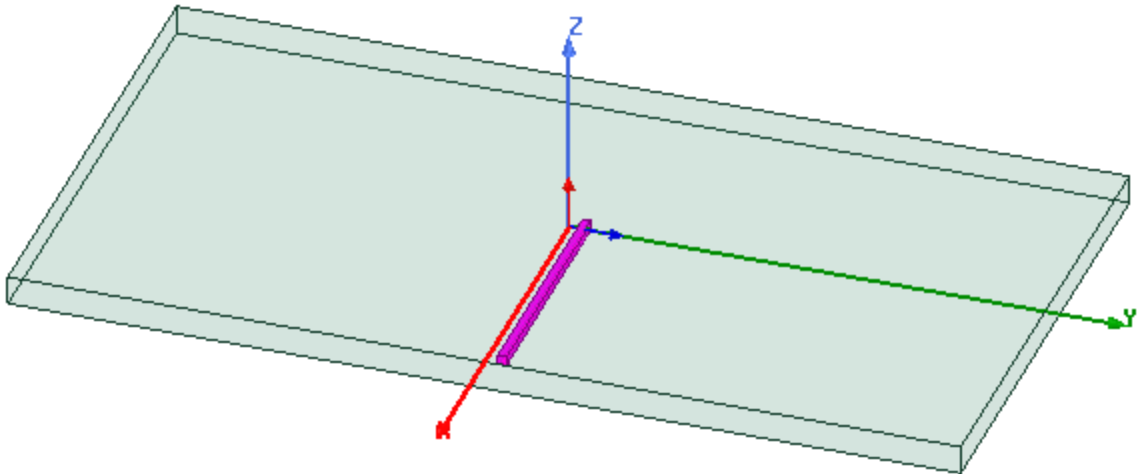

Move Bow Tie Object in -Z Direction

After the subtraction operation, perform the following steps to move the bowtie in the negative Z direction.

1. In the History Tree, right-click **BowTie** and choose **Edit > Arrange > Move** from the shortcut method.
2. At one of the Substrate corners, click the top vertex and then click the bottom vertex. This technique is convenient for specifying a -Z move vector. You will adjust the move distance in the next step.

As soon as you click the second vertex, the *Properties* dialog box appears.

3. Under the **Command** tab, replace the *Z coordinate* of the **Move Vector** value with the variable expression **-FeedWidth/2** and press **Enter**.

The *Evaluated Value* of the *Move Vector* updates to *0mm, 0mm, -0.3mm*.

Command				
	Name	Value	Unit	Evaluated Value
	Command	Move		
	Coordinate Sys...	Global		
	Move Vector	0mm, 0mm, -FeedWidth/2		0mm, 0mm, -0.3mm
	Suppress Com...	<input type="checkbox"/>		

4. Click **OK** to complete the move operation.

This move updates the Z position of the BowTie object such that half of its height is below the top face of the substrate and half is above the top face.

5. Click in the background area of the Modeler canvas to deselect the BowTie object. Your model should look like the following image:

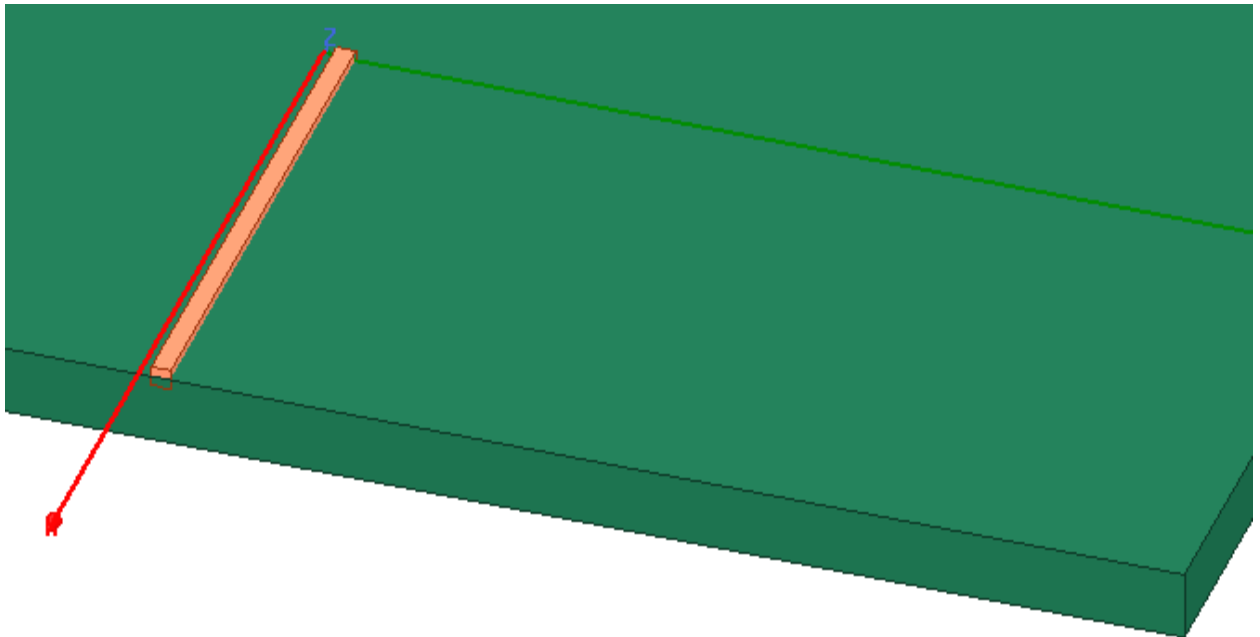

Create Starting Face for Flare Object

So far, only one coordinate system exists in our project (the *Global CS*). We need to create a Flare object. In preparation for creating this flare object, we will first create a Face CS. With the Face CS set as the working coordinate system you will create an object from the selected face then rotate and move it. Eventually, you will sweep this rotated face along a vector and create the flare. These steps will become clearer when you finish creating the flare object.

First, create the Face CS as follows.

1. Zoom in to the inside (-X) end of the BowTie object.
2. Press **F** to switch to the face selection mode.
3. Select the BowTie face, which lies along the global YZ plane, as shown below. If needed, zoom in further for a good view of the global origin.

Note:

Select a hidden face by clicking within its perimeter, which initially selects the face in front of the one you want. Then, press **B** (*Next Behind*) to select the desired face. For example, in this particular case, first select the top face of the bowtie object by pointing the cursor toward the next face (that you will eventually select), that is the end face. Then if you press B (Next Behind) the hidden end face gets selected.

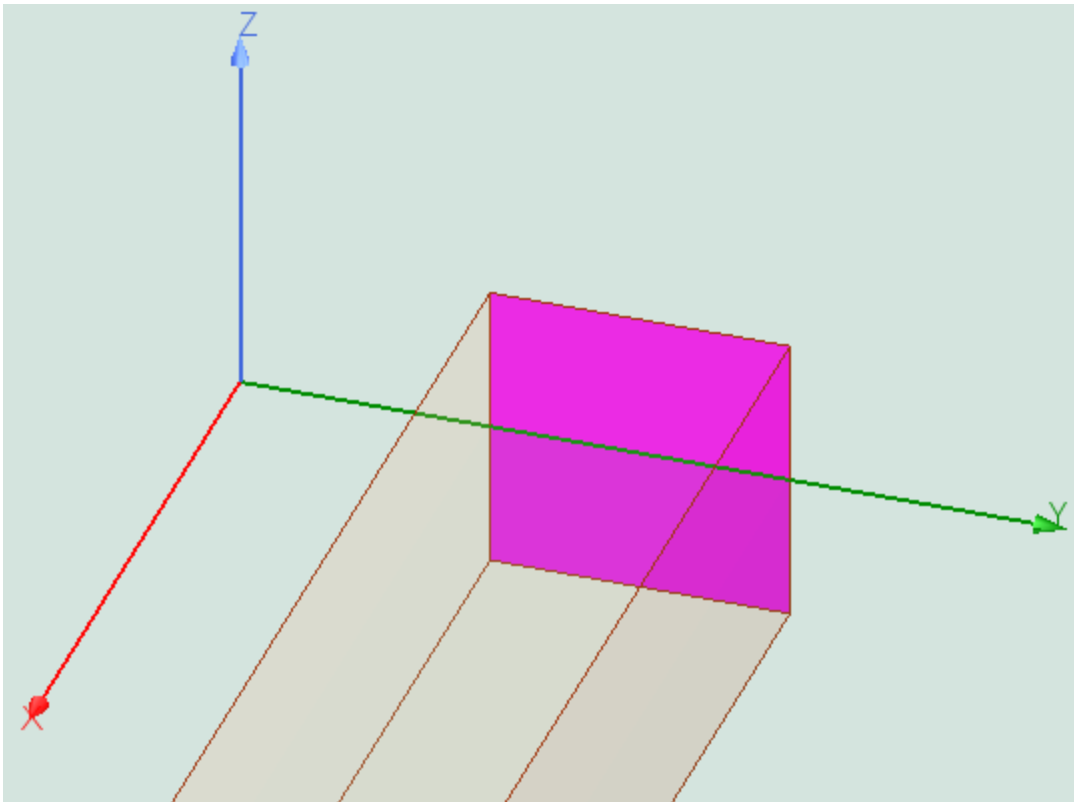

4. On the **Draw** ribbon tab, click  **Face CS**.
5. Click the centroid of the selected face and move the cursor along the Y axis to reach the edge of the face. Click again when the cursor changes to a triangle, which is the midpoint of the edge.

Note:

In the image, the origin is labeled as position 1 and the triangle on the edge is labeled as position 2.

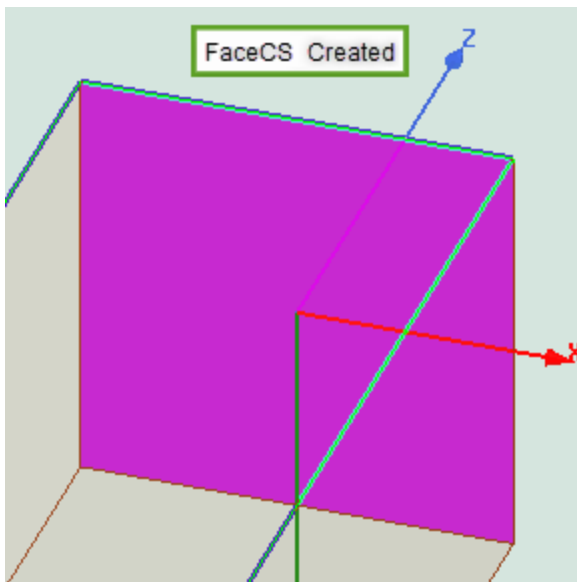
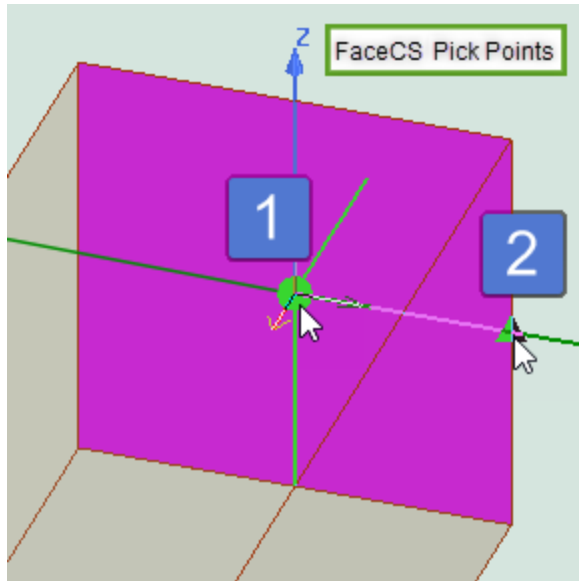

6. With the end face still highlighted, click  **Surface > Create Object From Face** from the **Draw** ribbon tab.

Do not deselect the new object.

7. From the **Draw** ribbon tab, click  **Rotate**.

8. Select the **Y Axis**, specify an **Angle of 90 deg**, and click **OK** to rotate the object to the orientation shown in the following image:

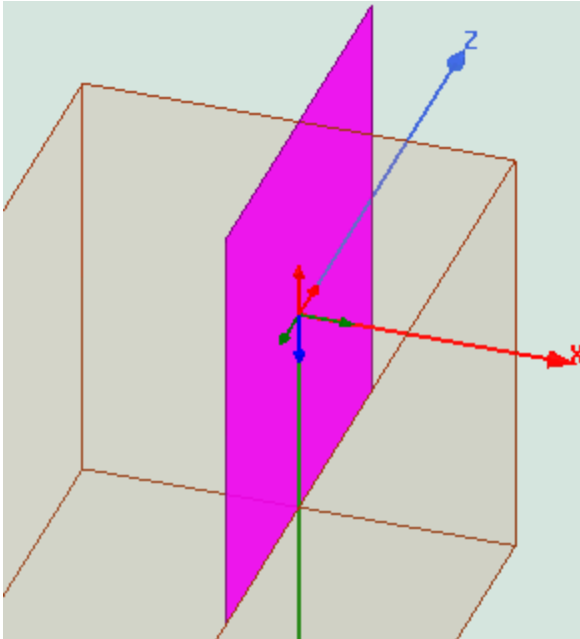

9. Click **OK** to close the *Properties* dialog box that appears.
10. From the **Draw** ribbon tab, click **Move**.
11. Click the center point of the selected face, move the mouse and then click the midpoint of the vertical feed edge to the left of the selected face, as shown below:

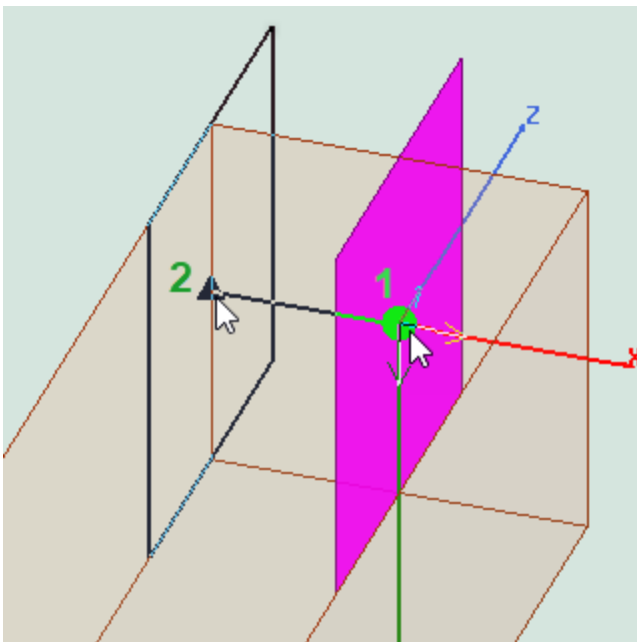

- In the **Command** tab of the *Properties* dialog box, edit the move vector to use the variable `FeedWidth`, as shown below:

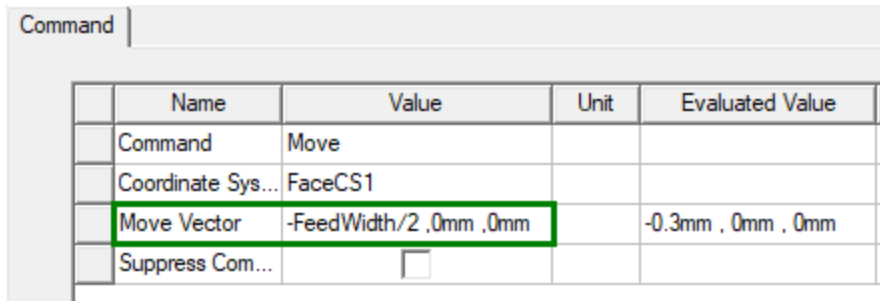

Name	Value	Unit	Evaluated Value
Command	Move		
Coordinate Sys...	FaceCS1		
Move Vector	-FeedWidth/2 ,0mm ,0mm		-0.3mm , 0mm , 0mm
Suppress Com...	<input type="checkbox"/>		

- Click **OK**.
- Press **Ctrl + D** to fit the view.

Create the Flare Geometry

Complete the following Modeler operations to create the flare object. You will begin by selecting, in the History Tree, the object created from a face in the preceding topic.

- Under *Sheets* in the History Tree, select **BowTie_ObjectFromFace1**.
- On the **Draw** ribbon tab, click  **Sweep along vector**.
- Click the substrate at the midpoint of one of its long edges. Then, click the corner vertex along the same edge in the +X axis direction of the current coordinate system, as indicated by green arrows in the following figure.

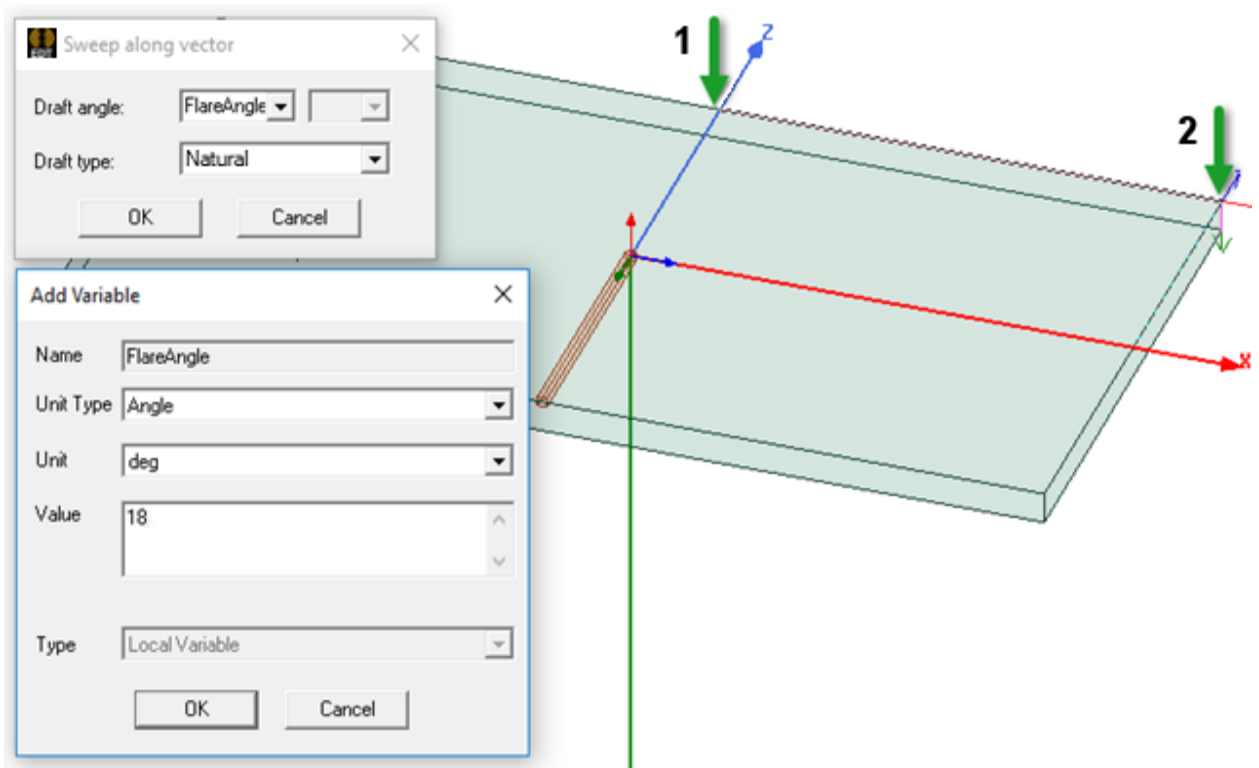
**Note:**

The working coordinate system should be *FaceCS1*. You can select it under the **Coordinate Systems** in the History Tree to make it active if it isn't already. Also, be very careful to snap to the midpoint of the long substrate edge (when the cursor changes to a triangle). This point locates the mirror plane. The second point dictates the normal direction to properly orient the mirror plane.

4. In the *Sweep along vector* dialog box, choose **Natural** from the **Draft Type** drop-down menu.
5. Define a variable called **FlareAngle** for the **Draft angle** and, in the *Add Variable* dialog box, set its value to **18 deg**.
6. Click **OK** on the *Add Variable* and *Sweep along vector* dialog boxes to close them.

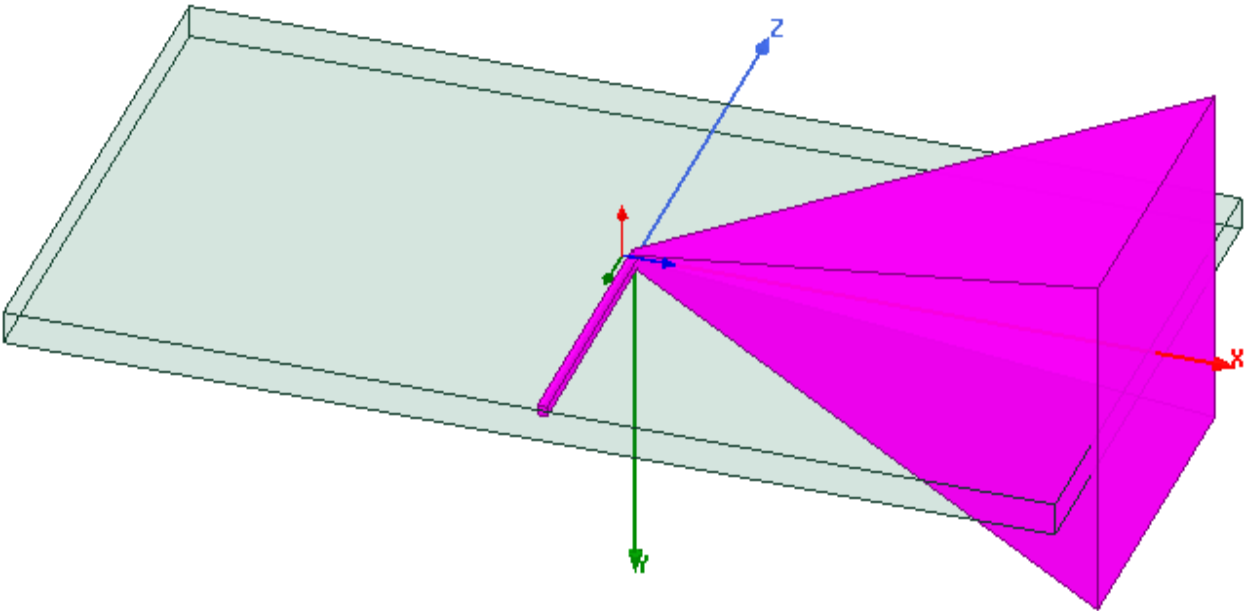

The *Properties* dialog box appears.

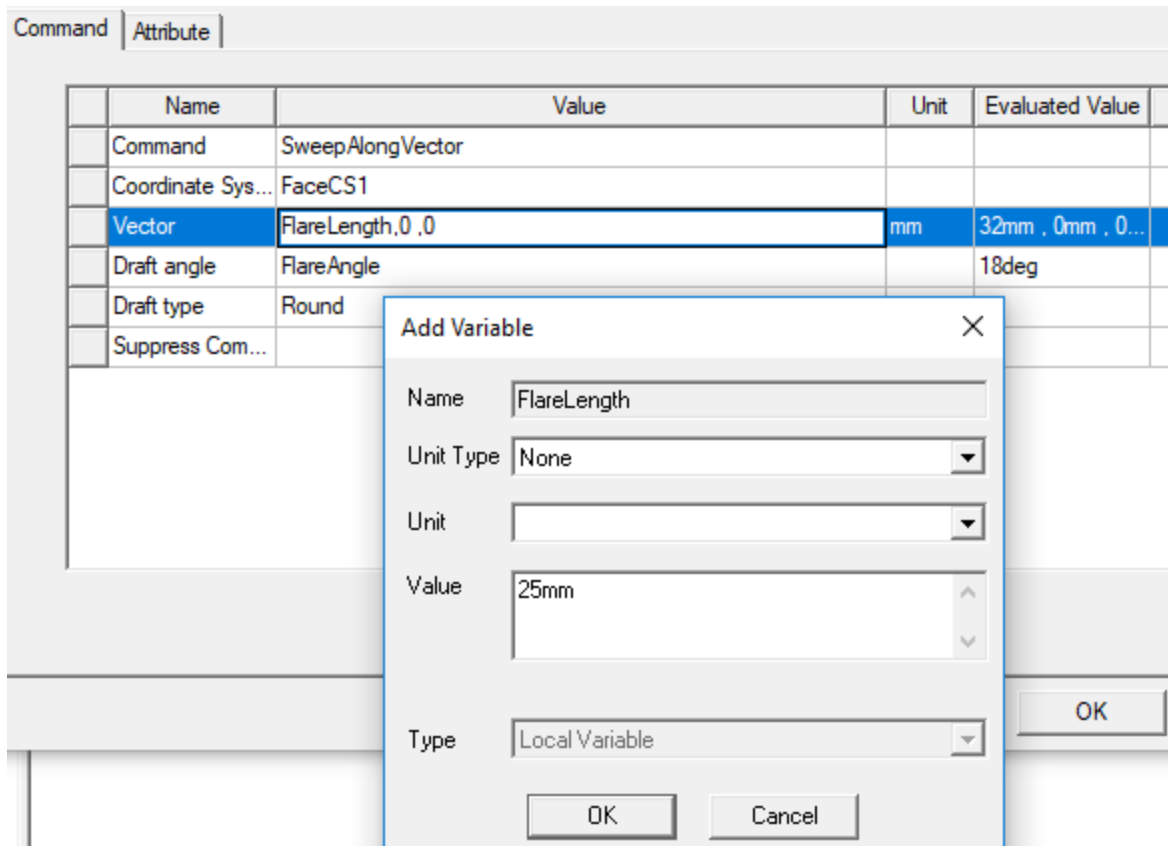

7. In the **Command** tab of the *Properties* dialog box, define a variable called **FlareLength** for the X coordinate of the **Vector** Value. Set **FlareLength** to **25 mm**, as shown in the preceding figure.
8. Click **OK** to close the *Add Variable* dialog box but leave the *Properties* dialog box open.
9. In the **Attribute** tab of the *Properties* dialog box, change the **Name** of the object to **Flare**.
10. Click **OK** to close the *Properties* dialog box.
11. Click in the Modeler canvas background area to deselect the object. Notice that the *Material* is already set to *copper*, since the Flare was derived from the face of a copper part.

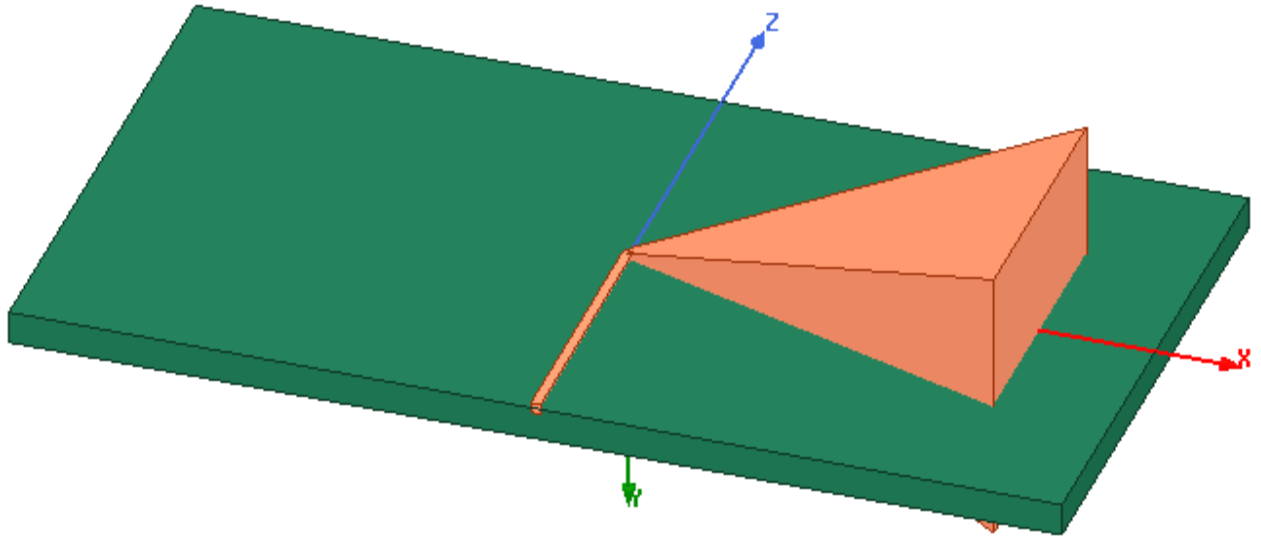

Create the Feed Inset

Create a parameter to vary the feed size. To do so, move the outer face of the bow tie along the normal direction by a variable length.

1. At this point click **Global** in the History Tree to make it the working the *Coordinate System*.
2. Zoom in to the outer face and press the **F** key to enter face selection mode.
3. Select the outer face of the BowTie.

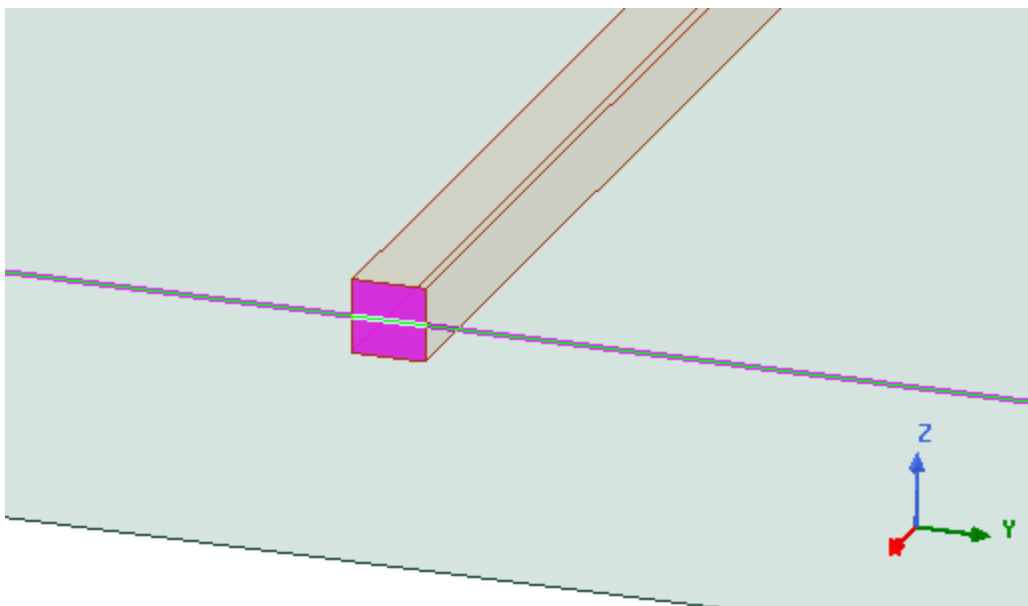

4. On the **Draw** ribbon tab, click  **Surface > Move Faces Along Normal**.

- For the **Distance** value, define a variable called **FeedInset** and assign a value of **-10 mm**.

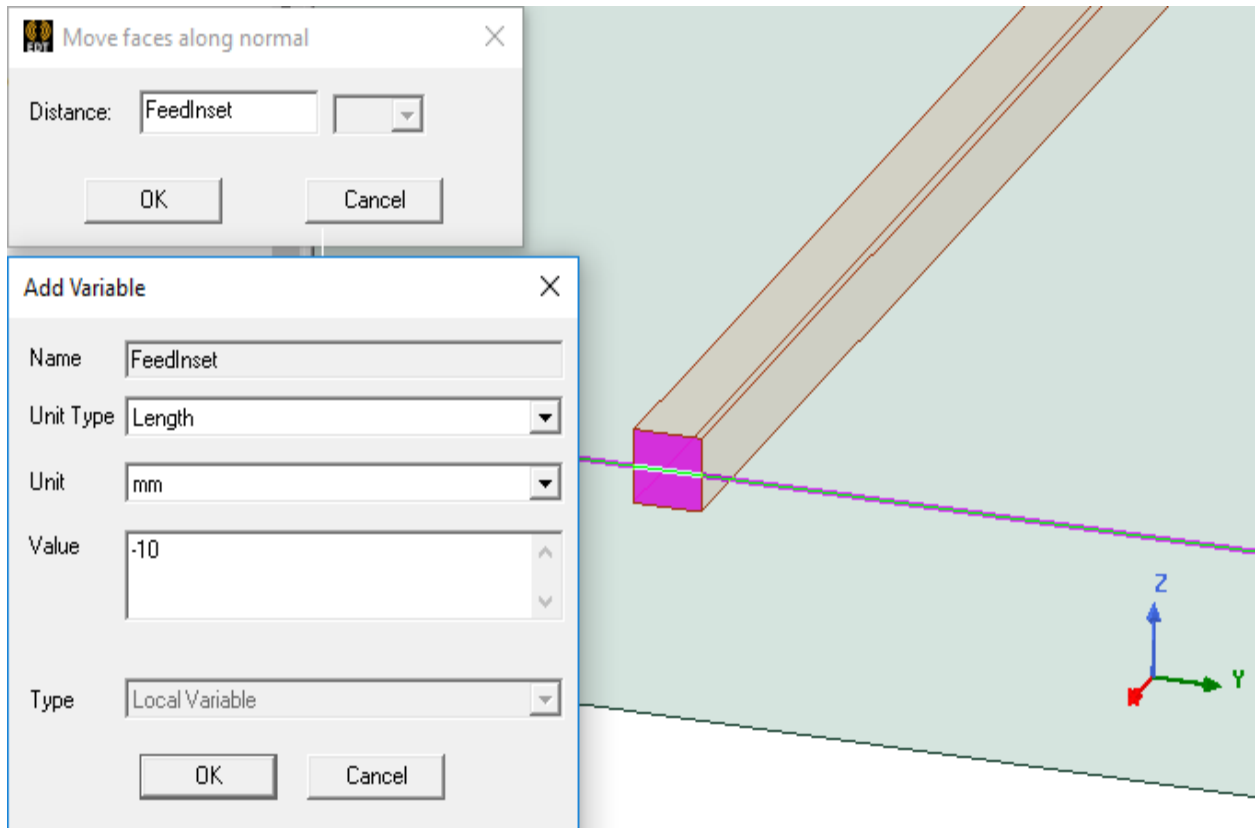

- OK** both dialog boxes.
- Click in the *Modeler* window's background area to deselect the face.

The BowTie feed length is modified as shown in the following figure:

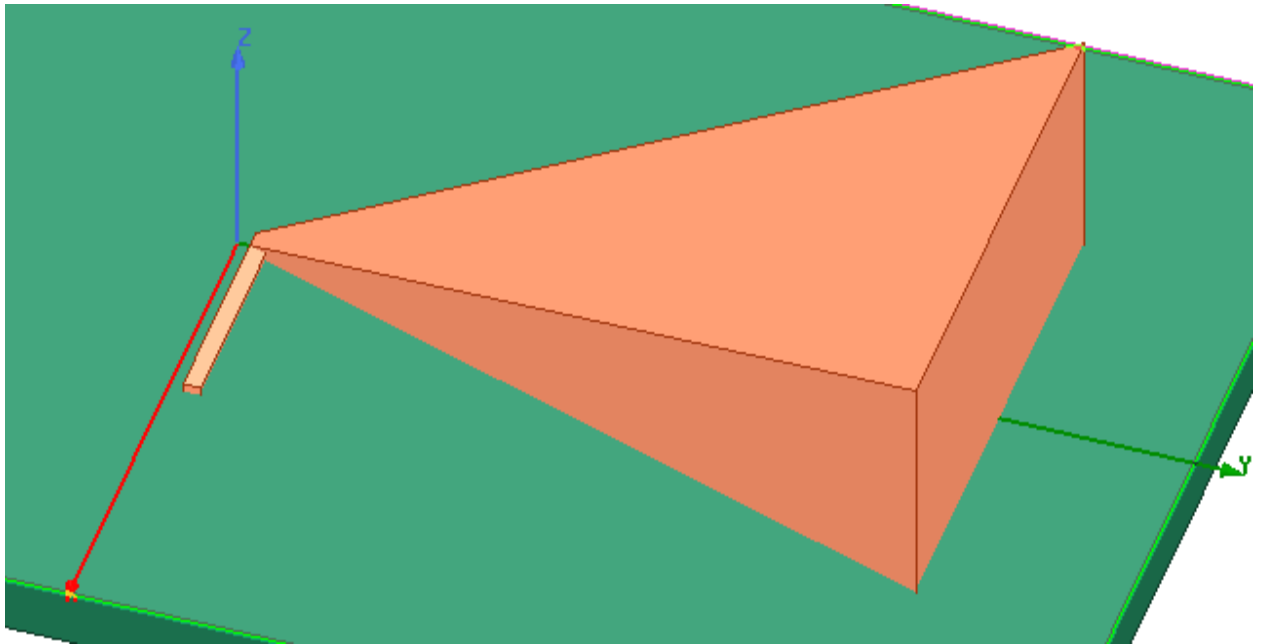



Create Face CS for Outer Feed Face

You need to create a second face coordinate system on the outward face (global +X end) of the BowTie. This new coordinate system will help you create an object from the selected face, rotate it, apply other modeler commands easily, and eventually create the precursor object for the port.

Before you begin this procedure, ensure that the current working coordinate system is **Global**.

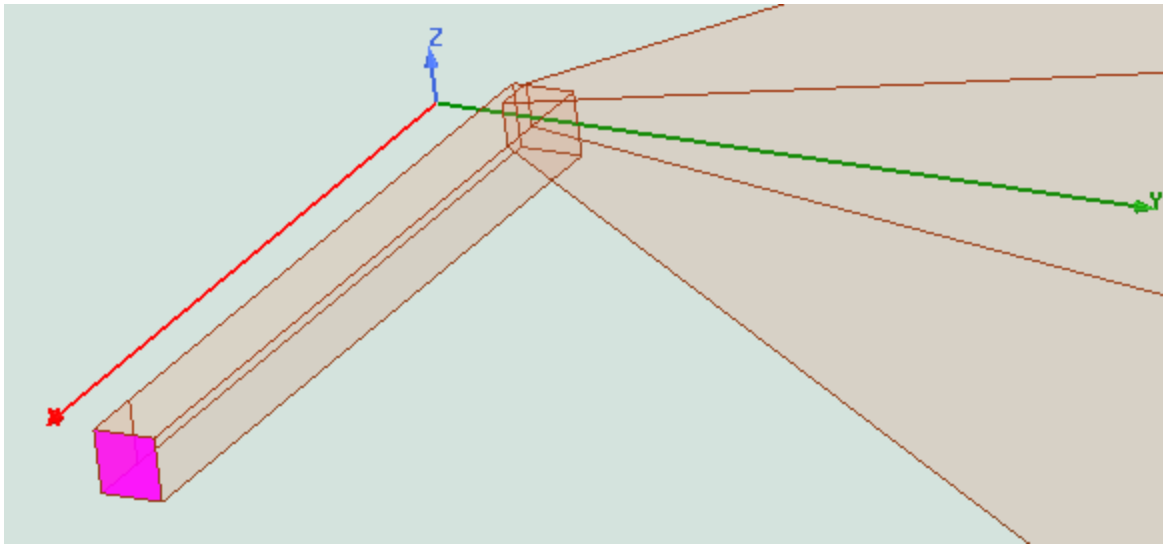
1. Zoom in to the feed and press **F** to enter face selection mode.
2. Select the outer end face.



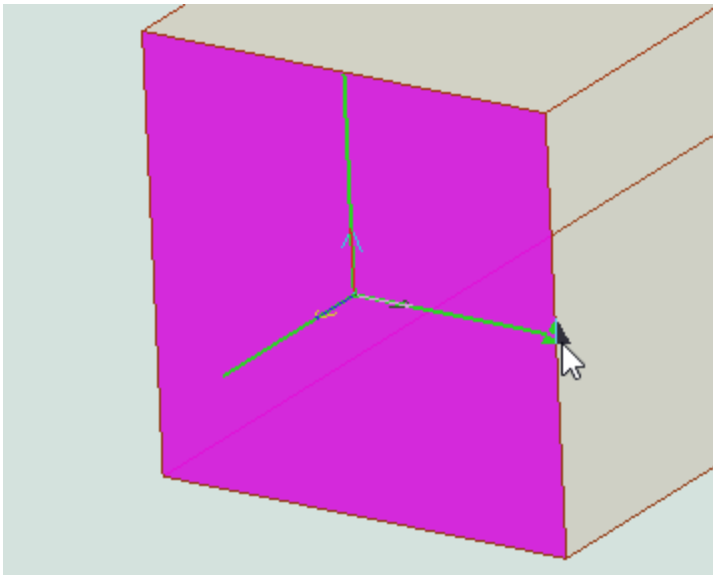

3. From the **Draw** ribbon tab, click  **Fit Selected**.
4. On the **Draw** ribbon tab, click  **Face CS**.
5. Click when the cursor changes to a circle at the center of the face, drag along the global +Y direction to the midpoint of the edge, and click again when the cursor changes to a triangle. This action establishes the X axis of the new face coordinate system (*FaceCS2*).





Do not deselect this face.

Creating the Port Area Object

With the outer face of the bow tie feed still selected, perform the following steps.

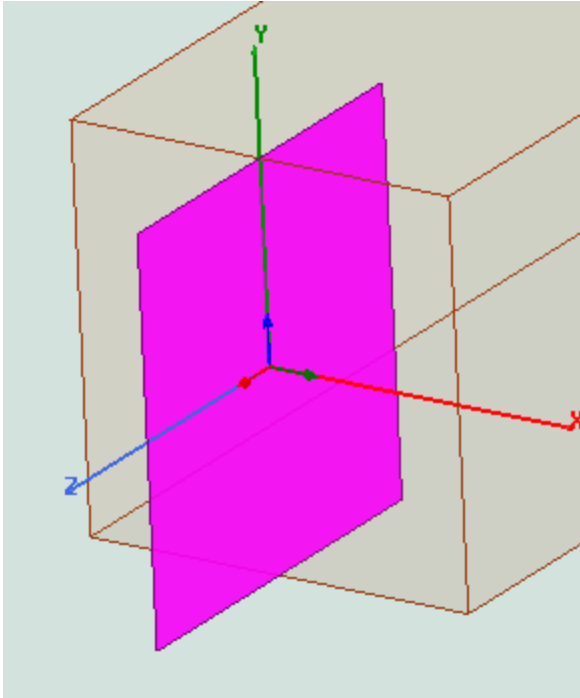
1. From the **Draw** ribbon tab, click  **Surface** > **Create Object From Face**.
2. From the **Draw** ribbon tab, click  **Rotate**.
3. Select the **Y Axis**, specify an **Angle** of **90 deg**, and click **OK** to rotate the object to the orientation shown in the following image:



4. Click **OK** to close the *Properties* dialog box that appeared after rotating the object but keep the new object selected.
5. On the **Draw** ribbon tab, click  **Move**.
6. Move the object's near top corner to the top left corner of the bow tie feed that lies in the *FaceCS2* YZ plane, as shown below.

Observe that the cursor changes to a square at each of the corner vertices.

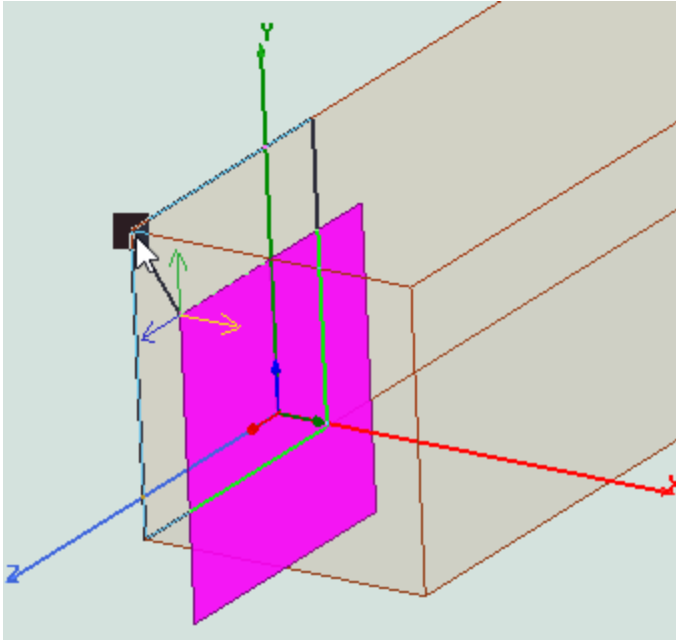

The *Properties* dialog box displays as soon as you click the second vertex.

- In the **Command** tab of the *Properties* dialog box, ensure that the **Coordinate System** is set to **FaceCS2**. Then, edit the **Move Vector** value so that the X, Y, and Z coordinates are **-FeedWidth/2, 0mm, and -FeedWidth/2**, respectively, as shown in the following figure:

Command		Attribute		
Name	Value	Unit	Evaluated Value	
Command	Move			
Coordinate Sys...	FaceCS2			
Move Vector	-FeedWidth/2 ,0mm ,-FeedWidth/2		-0.3mm , 0mm , -0.3mm	
Suppress Com...	<input type="checkbox"/>			

- Click **OK** to close the *Properties* dialog box.

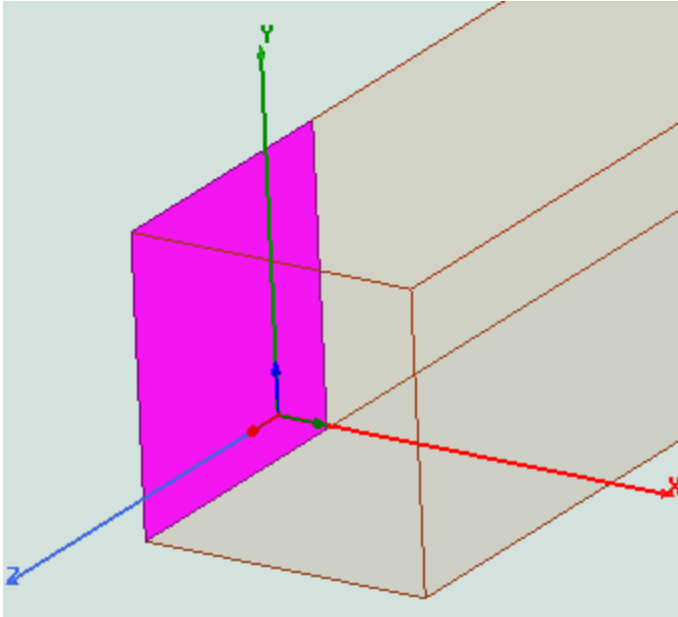

9. Click in the background area of the History Tree to clear the current selection.
10. Under **Coordinate Systems** in the History Tree, select **Global** as the working coordinate system.
11. Under **Sheets > Unassigned** the History Tree, select **BowTie_ObjectFromFace1**.
12. On the **Draw** ribbon tab, click **Sweep along vector**.
13. Click on the centroid of the front face of the feed, move the mouse, and click on the midpoint of the left vertical edge of the same face, as shown below:

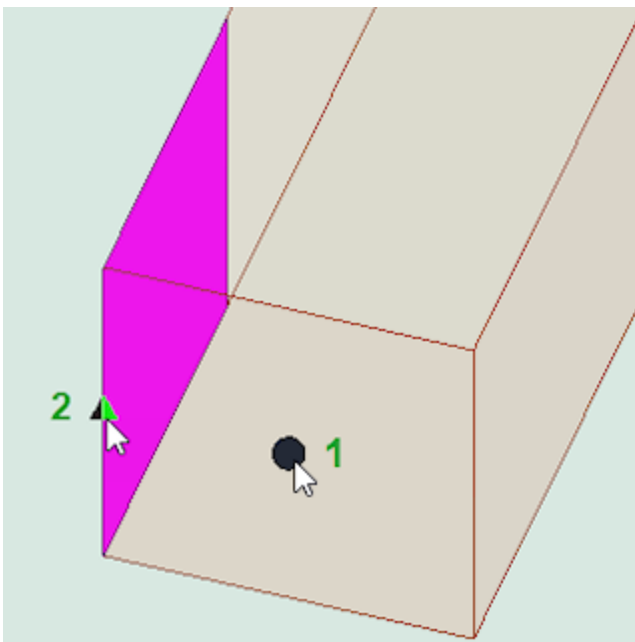

This action establishes the sweep vector direction, but you need to adjust the length of the sweep in the next step.

14. In the *Sweep along vector* dialog box, choose **0deg** from the **Draft angle** drop-down menu and click **OK**.
15. In the **Command** tab of the *Properties* dialog box, ensure that the **Coordinate System** is set to **Global**. Then, edit the **Move Vector** value so that the X, Y, and Z coordinates are **0mm**, **-Gap/2**, and **0mm**, respectively, as shown in the figure below.

Command		Attribute		
Name	Value	Unit	Evaluated Value	
Command	SweepAlongVector			
Coordinate Sys...	Global			
Vector	0mm , -Gap/2 , 0mm		0mm , -0.5mm , 0mm	
Draft angle	0	deg	0deg	
Draft type	Natural			
Suppress Com...	<input type="checkbox"/>			

16. In the **Attribute** tab, change the **Name** to **PortArea** and press **Enter**.
17. Click **OK**. Your model should look like the following figure:

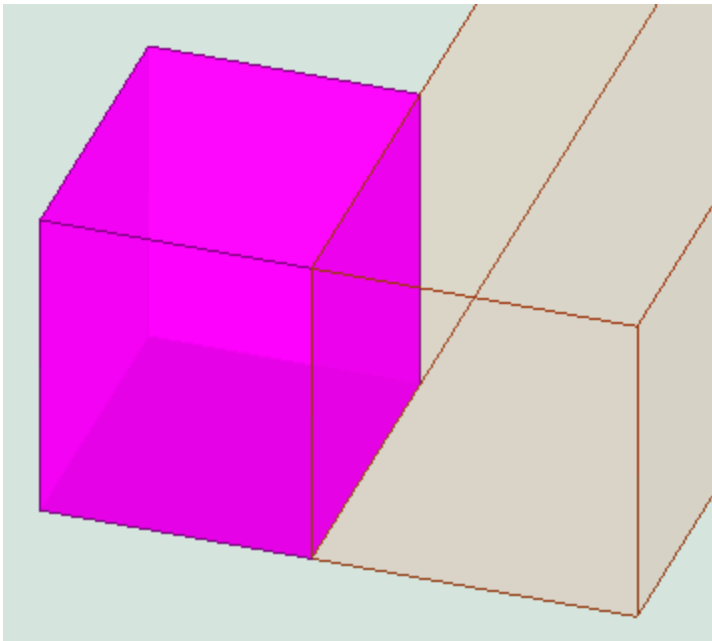

Note:

The left side face of the object you just created lies on the global XZ plane, which is the mirror plane you will specify when making the other half of the bow tie antenna.

Unite the Bow Tie Objects

Next, you will mirror and then unite all of the copper objects—the *BowTie*, *Flare*, and *PortArea* objects.

In subsequent procedures, you will create a ground plane object (GND) on the top face of the substrate and apply a finite conductivity boundary condition to it. Next, you will subtract the united BowTie object from the ground plane. The sole purpose of the united BowTie object is to use it as a cutting tool to create a bow tie shaped opening in the ground plane. Therefore, for the final modeling procedure, you will deactivate and hide the solid BowTie object, leaving the Substrate and GND as the only active and visible model parts.

First, let's unite the copper objects.

1. Press **Ctrl + D** to fit the entire model to the Modeler window.
2. Click in the Modeler window's background area to clear the current selection.
3. Under **copper** in the history, select **BowTie**. Then, holding **Ctrl**, also select **Flare** and **PortArea**.
4. From the **Draw** ribbon tab, click  **Thru Mirror** (Mirror Duplicate).
5. Click the midpoint of one of the long substrate edges and then click the corner vertex along the same edge, as shown below:

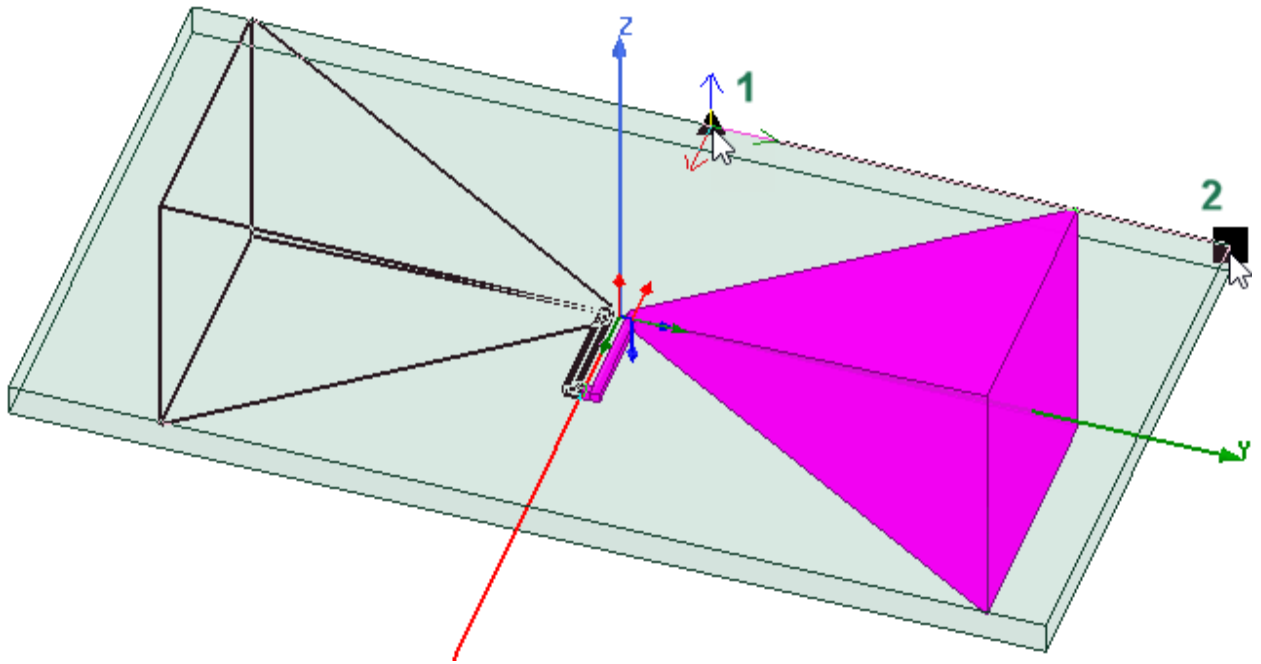

As soon as you click the second vertex, the *Properties* dialog box appears.

6. Click **OK** to close the *Properties* dialog box and click in the Modeler window's background area to deselect the objects.

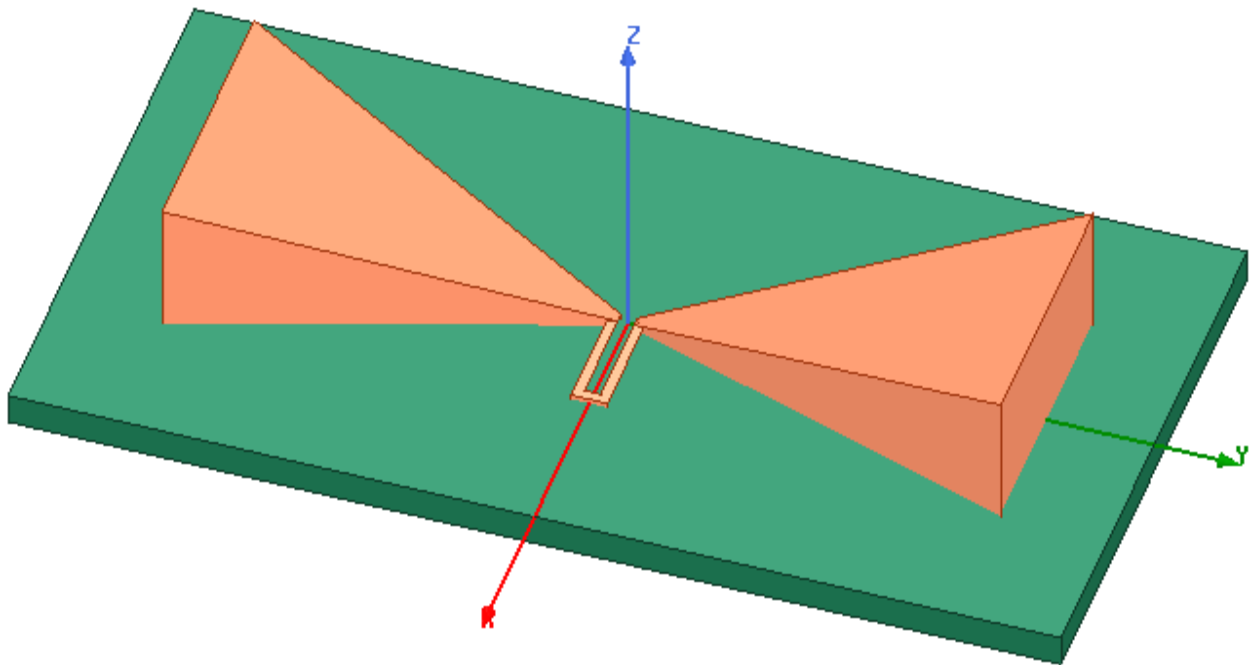

7. In the History Tree, select **BowTie**. Then, while holding down **Ctrl**, select each of the other objects under **copper**.

The full set of objects to be selected includes **BowTie**, **BowTie_1**, **Flare**, **Flare_1**, **PortArea**, and **PortArea_1**.

8. With these objects selected, click  **Unite** on the **Draw** ribbon tab.

All of the objects are united into a single object named **BowTie**.

9. Click in the Modeler window background to clear any selection. Then, select **BowTie** under **copper** in the History Tree.

With this one item selected, the entire model is highlighted, with the exception of the substrate, verifying that all copper objects have been united into a single part.

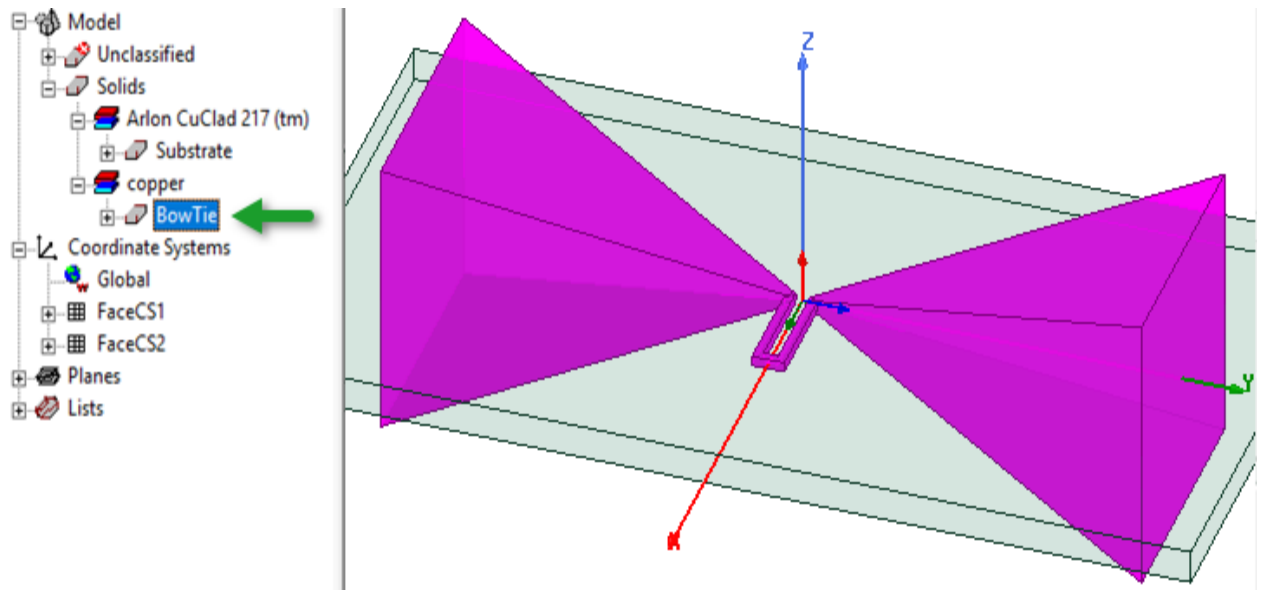

Create the Ground Plane

You will now create a ground plane from the top surface of the substrate.

1. Press **F** to enter face selection mode and select the top face of the substrate as shown in the following figure.

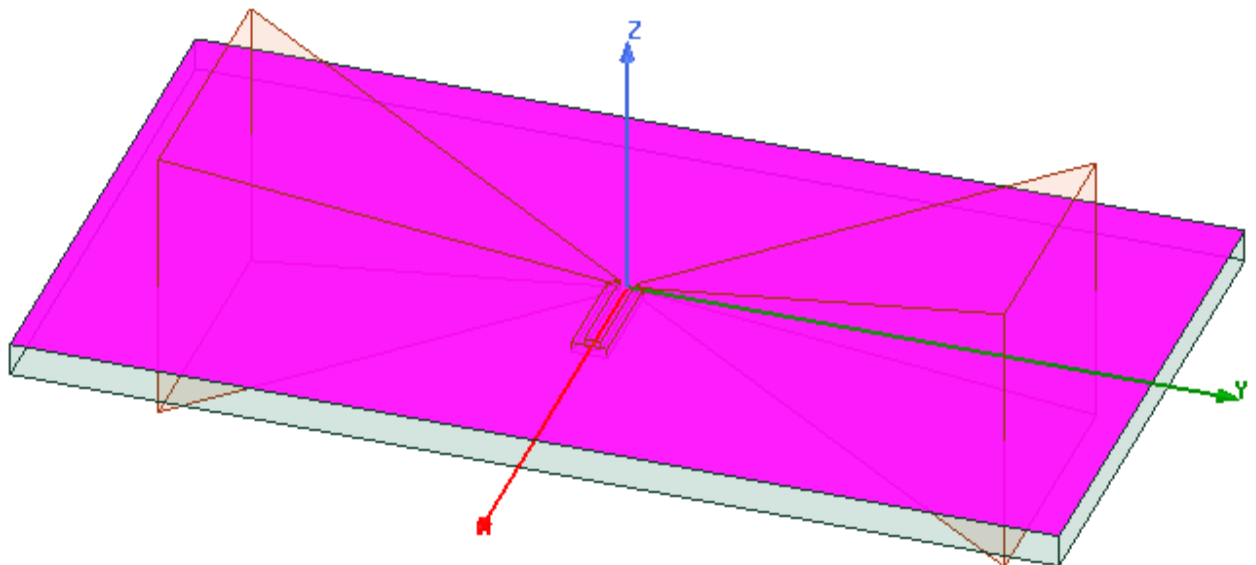

2. On the **Draw** ribbon tab, click  **Surface > Create Object From Face**. Do not deselect the resultant object yet.
3. In the docked *Properties* window, change the **Name** of the new object from *Substrate_ObjectFromFace1* to **GND**.
4. Change the **Color** for the *GND* object to a **orange** to differentiate it from the Substrate, and because it will represent a copper conducting layer.

Do not be concerned that the ground plane is the same color as the BowTie object because we will soon be deactivating and hiding that part.

5. Click **OK** to apply the changes and close the *Properties* dialog box.
6. Click in the Modeler window's background area to deselect the ground plane.

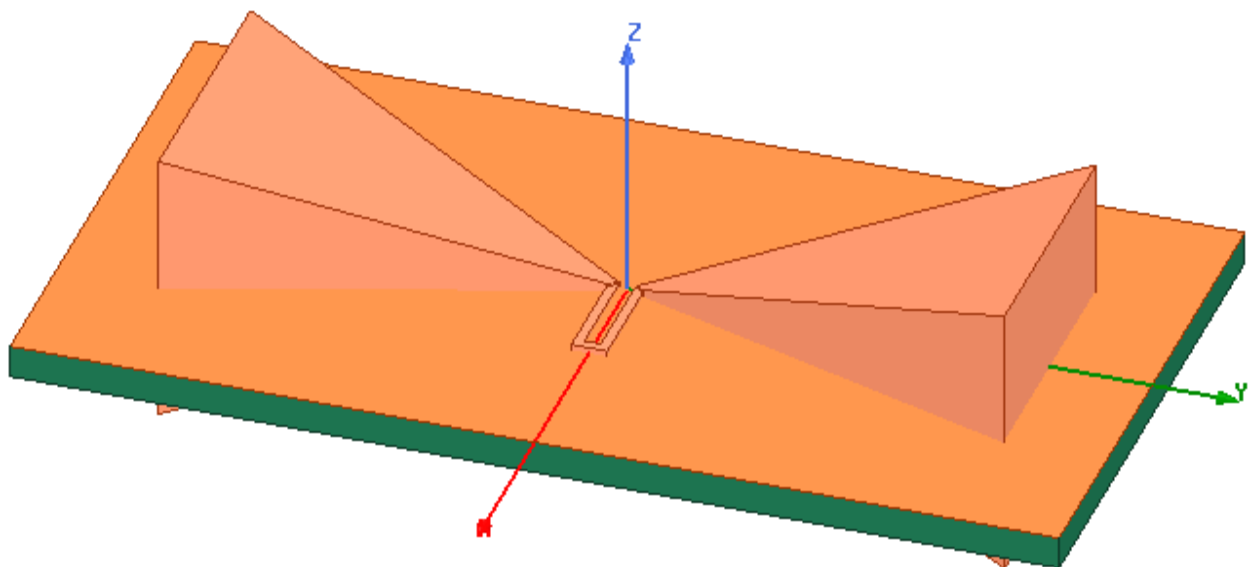

Assign Finite Conductivity Boundary

To assign a boundary condition to the antenna do the following.

1. Under *Sheets > Unassigned* in the History Tree, right-click **GND** and select **Assign Boundary > Finite Conductivity**.

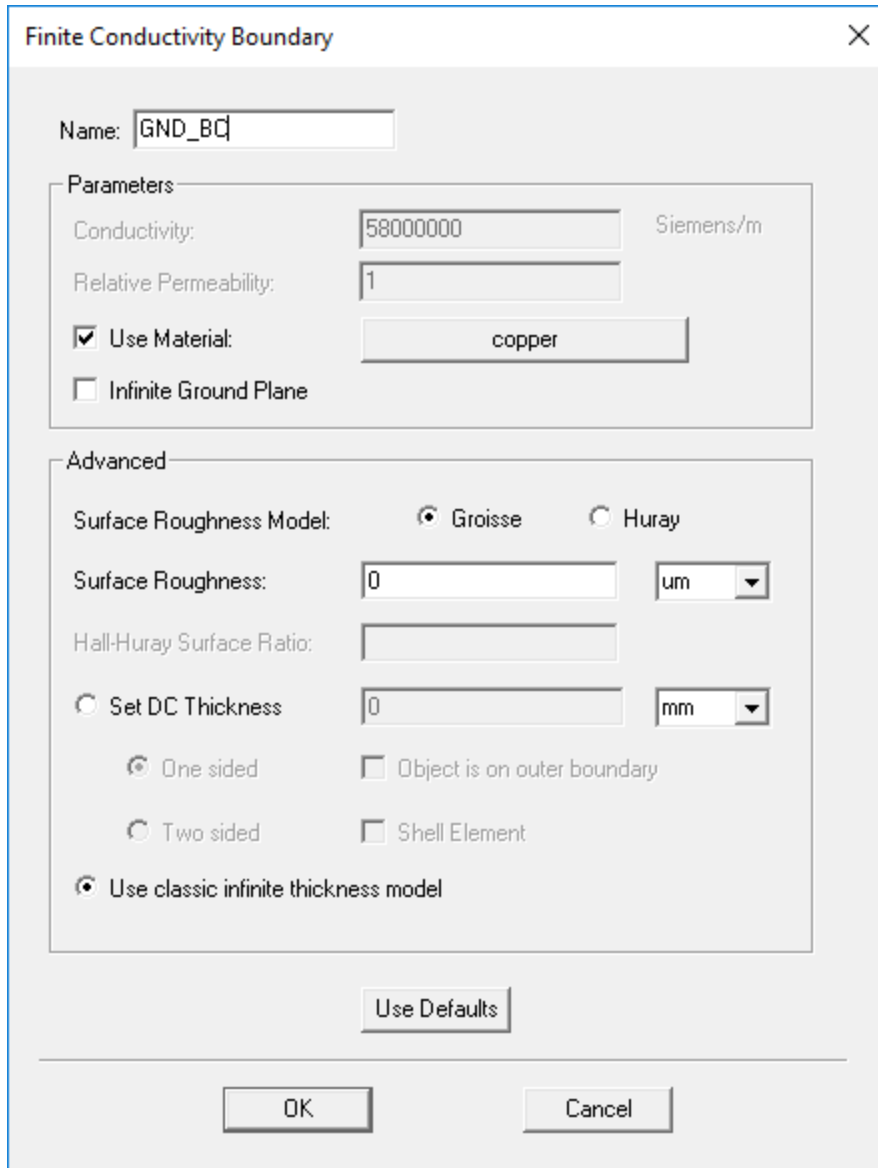

2. Change the boundary **Name** to **GND_BC**.
3. Select **Use Material** and click the button to the right of this checkbox. Then, choose **copper** from the list of library materials.
4. Click **OK** three times to close the pop-up "New definition not used" material message and the *Select Definition* and *Finite Conductivity Boundary* dialog boxes.
5. Click **GND_BC** under **Boundaries** in the *Project Manager* to view the finite conductivity boundary if it is not already displayed.

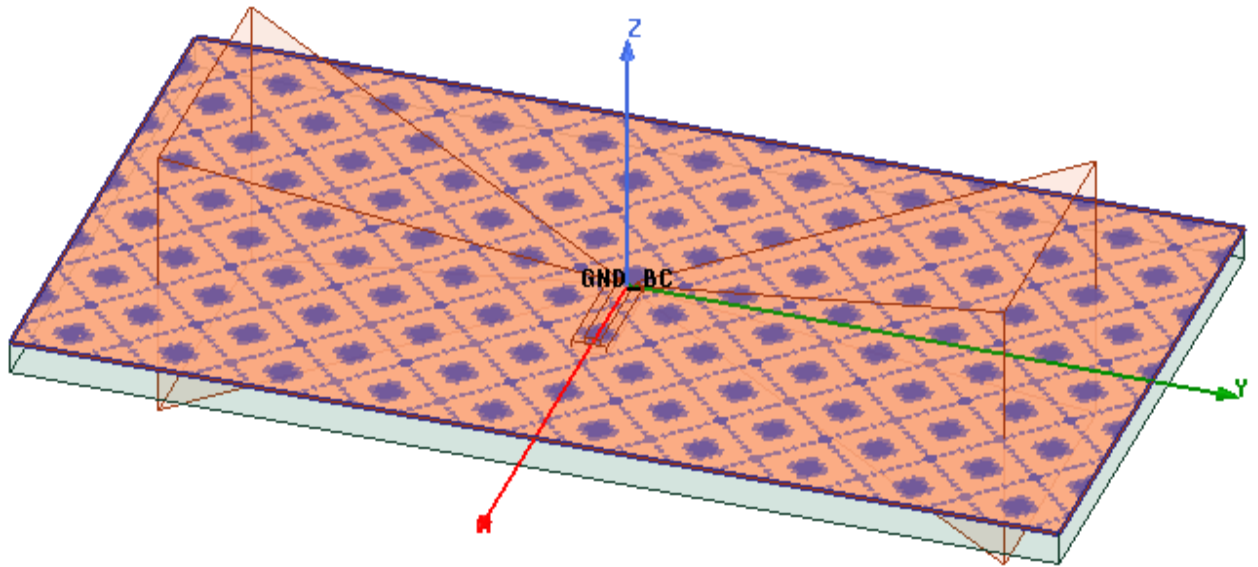

Subtract Bowtie From GND

In this section we describe how to subtract the bowtie object from the ground plane.

1. Click in the Modeler window background area to deselect the boundary condition.
2. Under *Sheets > Finite Conductivity* in the history tree, select **GND**.
3. Holding down **Ctrl**, also select **BowTie** (under *Solids > copper*).
4. From the **Draw** ribbon tab, click  **Subtract** (or access this Boolean command from the Modeler menu).
5. Select **Clone tool objects before operation** and click **OK**.

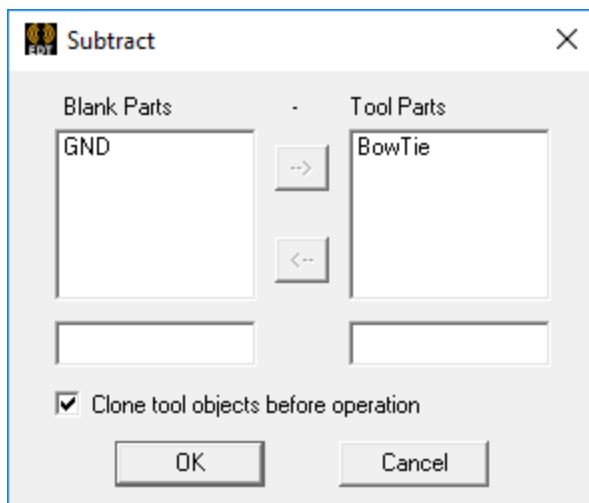

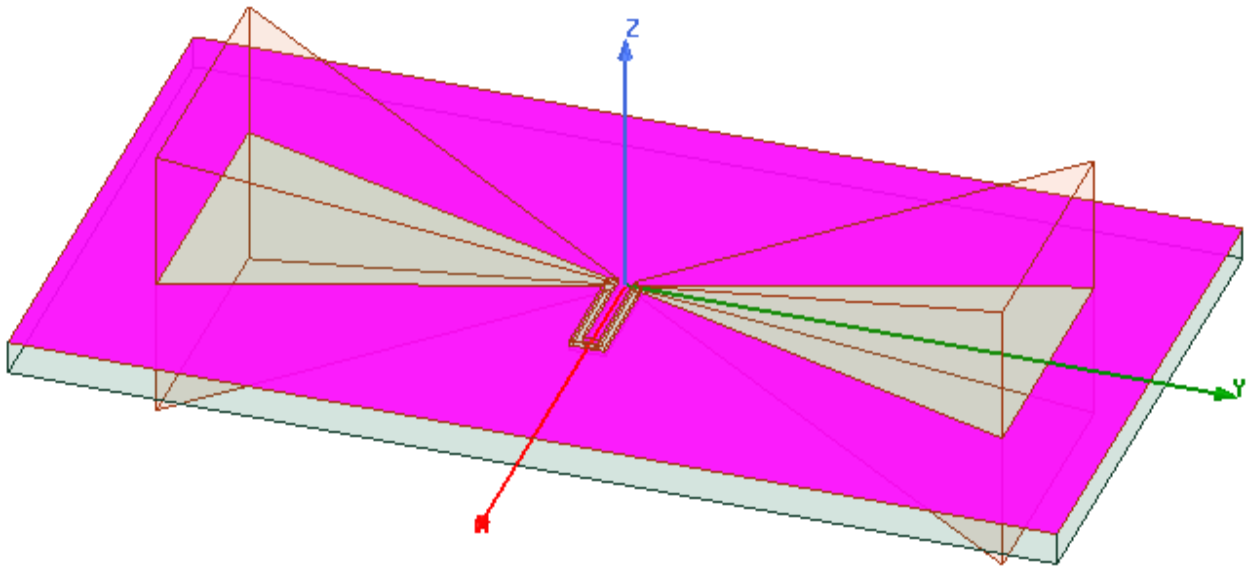

6. Select **BowTie** in the History Tree. Then, in the docked *Properties* window, clear the **Model** option.

The BowTie becomes a Non-Model object, and the solver will ignore it.

7. Under *Non-Model* in the History Tree, right-click **BowTie** and click **View > Hide In All Views**.

The BowTie object is no longer visible.

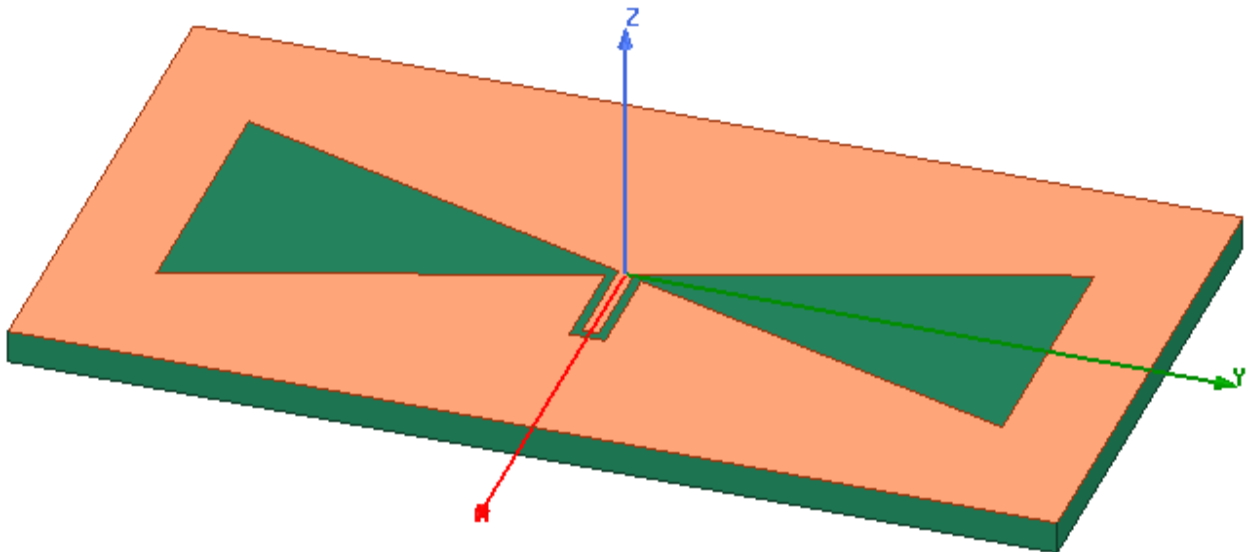

8. Select **GND_BC** under *Boundaries* in the *Project Manager* and verify that your model resembles the following figure:

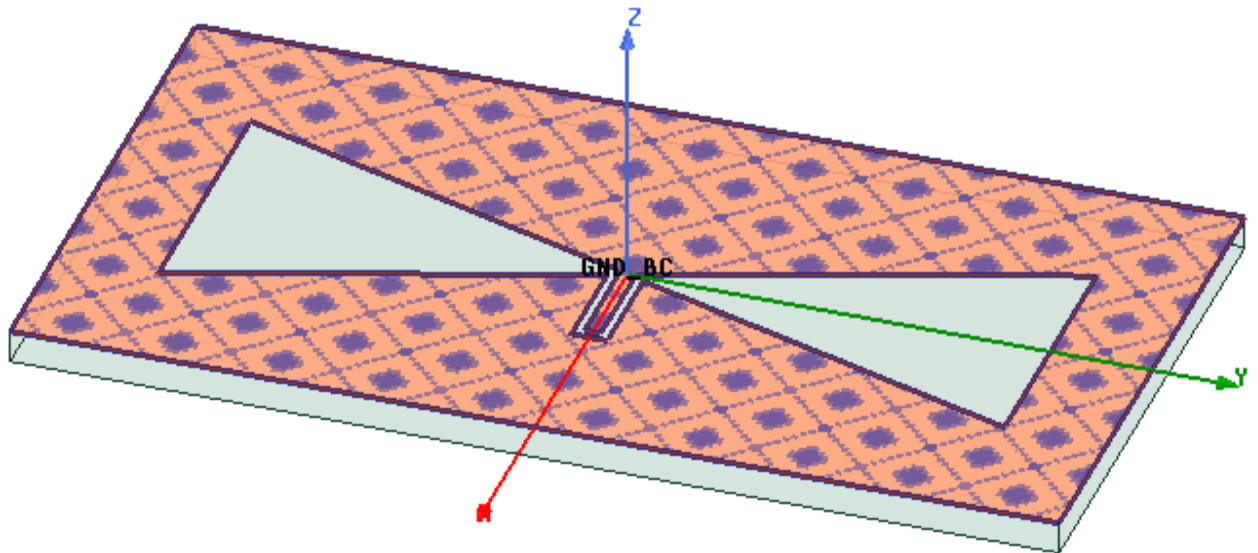

9. Click in the Modeler window's background area to clear the boundary condition selection.

3 - Simulation and Results

Once the geometry is complete the next set of operations include the following:

- Assign Excitations
- Specify Solution Frequency
- Run the Analysis
- Perform Post Processing

This chapter covers the above mentioned operations.

Assign Excitations

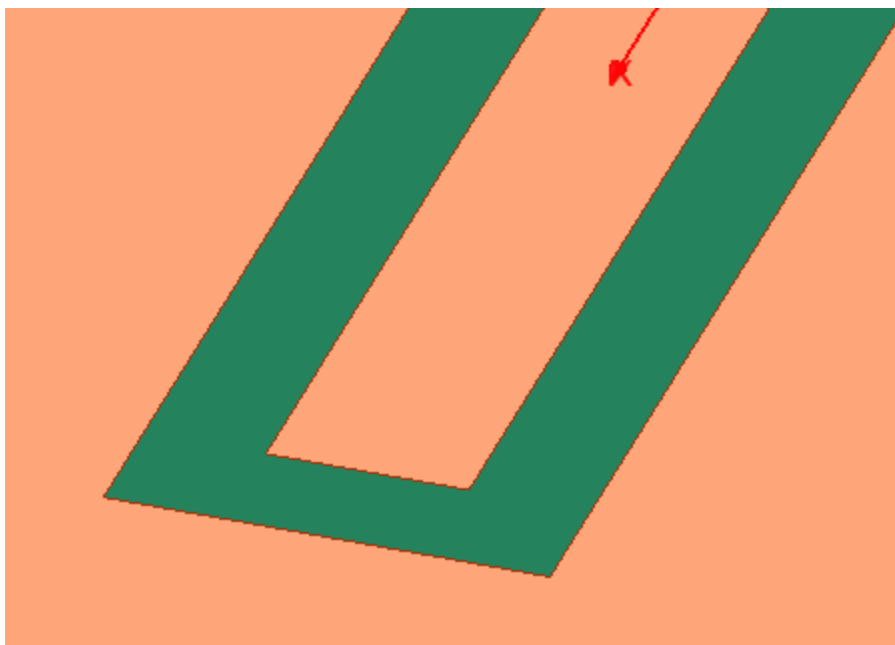

To excite the bow-tie antenna we will assign a lumped port.

1. Zoom in to the port area of the *GND* object as shown below:

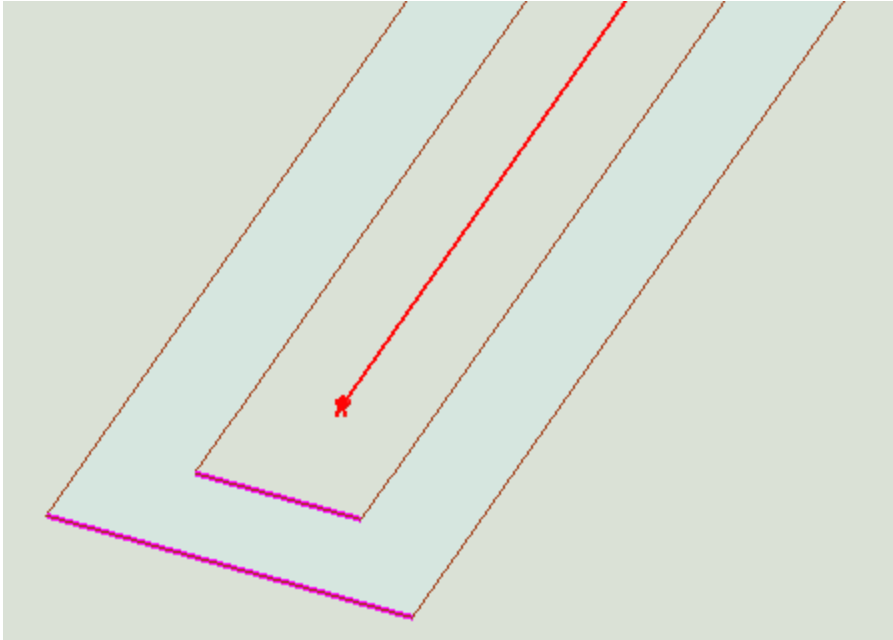

2. Press **E** to switch to the edge selection mode.
3. Click one of the two edges shown below then, holding **Ctrl**, click the other edge to also select it.



4. On the **Draw** ribbon tab, click  **Edge > Create Object From Edge**.
5. On the **Draw** ribbon tab, click  **Surface > Connect**.

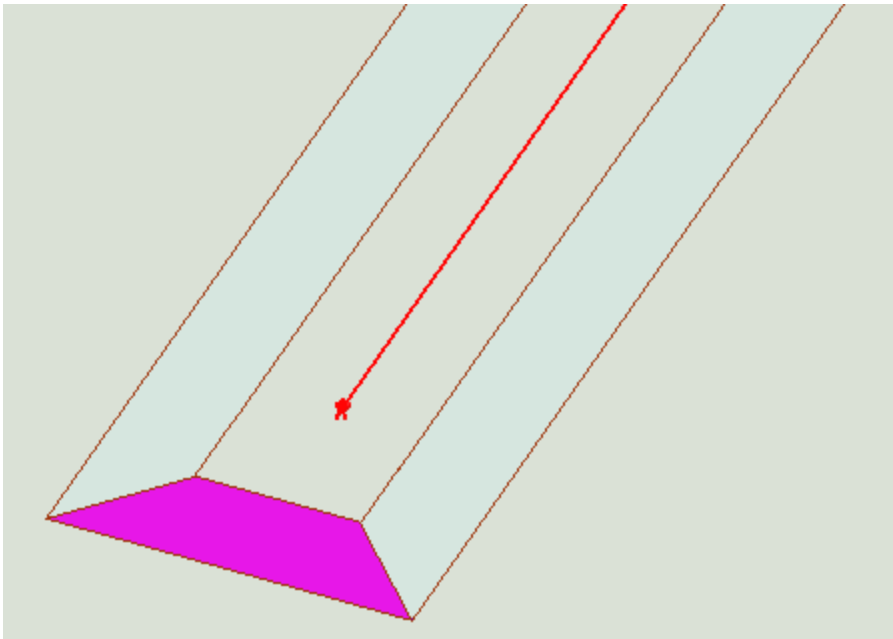

6. With the surface connecting the two edges still selected, right-click in the Modeler window and select **Assign Excitation > Port > Lumped Port**.

The *Lumped Port* dialog box appears.

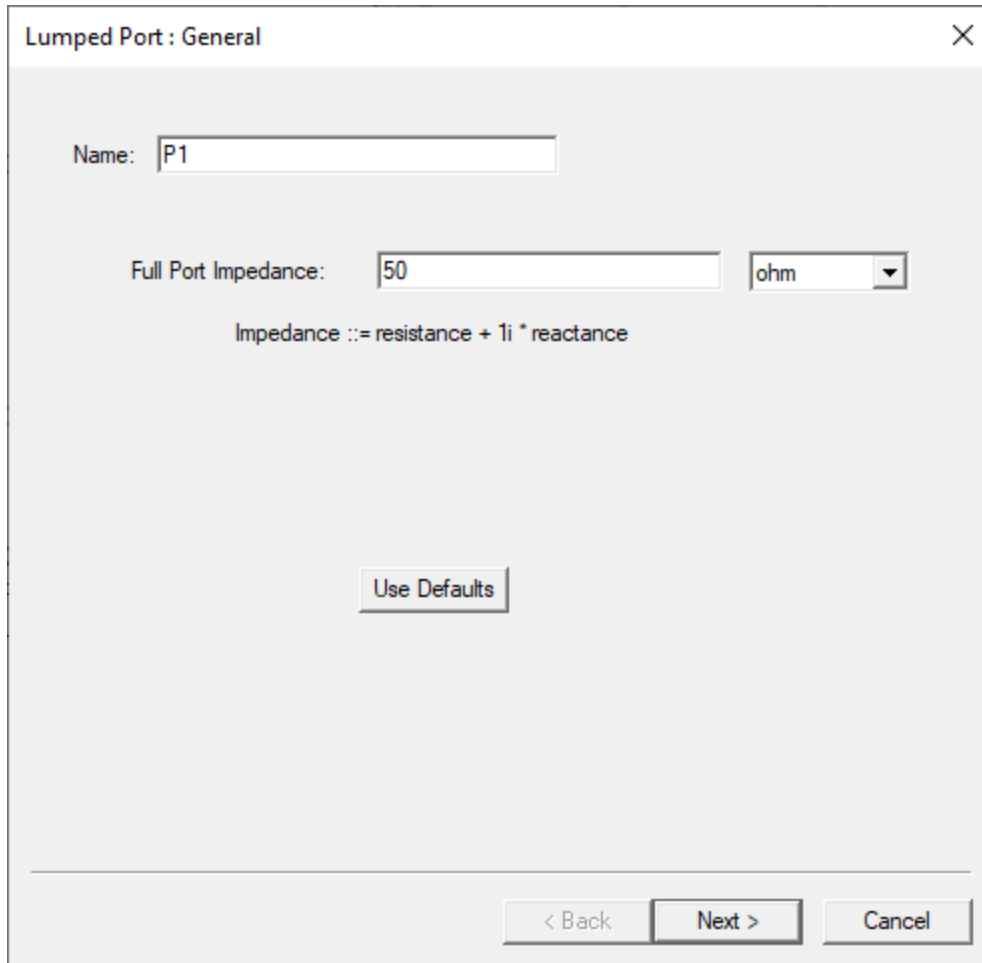

7. Change the **Name** to **P1**, keep the remaining options in the first panel at their defaults settings, and click **Next**.
8. From the drop-down menu in the first row of the **Integration Line** column, choose **New Line**. Then, draw an integration line from the midpoint of the longest edge of the selected face to the midpoint of the shortest edge of the same face, as shown in the following figure.

Note:

The cursor will snap to the midpoint of an edge when the cursor changes to a triangle.

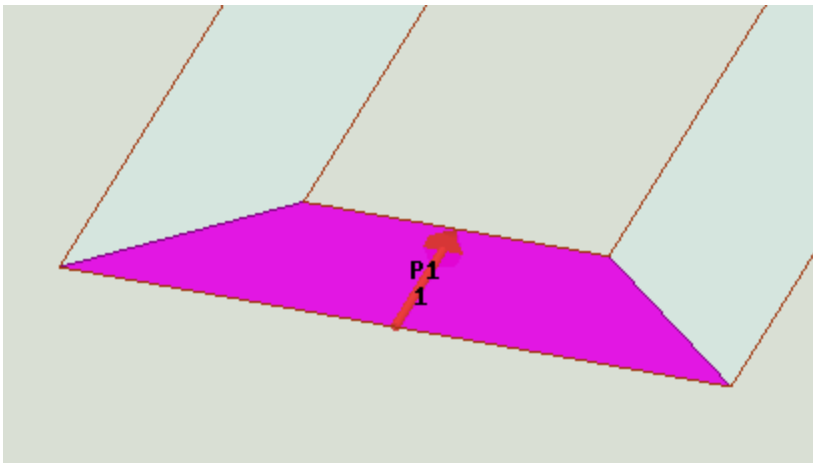
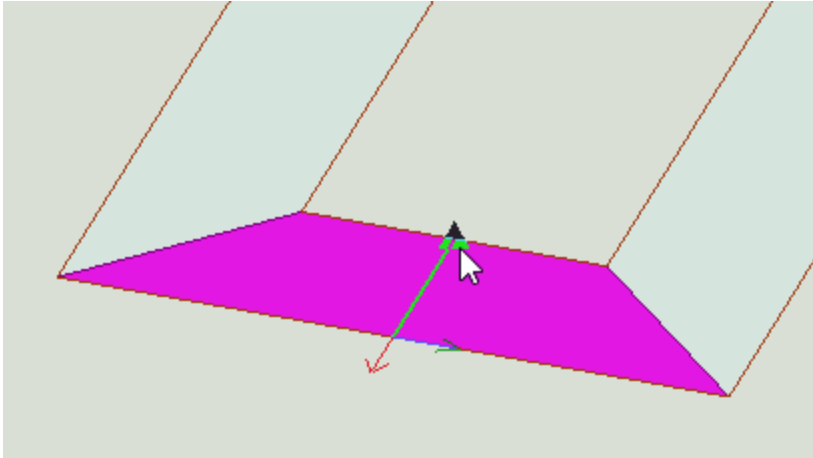

9. Click **Next** and then **Finish** to complete the lumped port assignment.
10. If the visualization of the lumped port excitation is not already displayed, select **P1** under *Excitations* in the Project Manager.

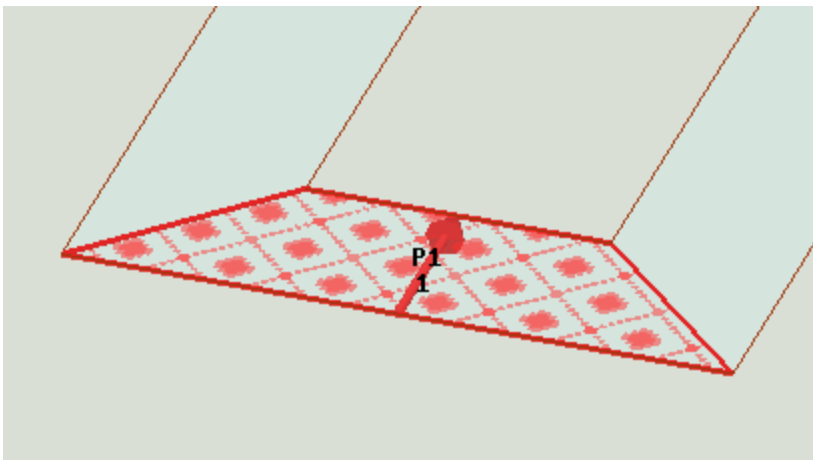

11. Press **Ctrl + D** to fit the model to the viewing area.

Define Solution Frequency

This section describes how to define an operating frequency for simulating the bow tie antenna. If you want to generate a solution across a range of frequencies you can also define a frequency sweep.

1. Right-click **Analysis** in the Project Manager and select **Add Solution Setup > Advanced** from the shortcut menu.
2. In the **General** tab of the *Driven Solution Setup* dialog box, make the following changes:
 - Change the **Setup Name** to **10GHz**, since the operating frequency is a more meaningful name than the default one.
 - Specify a **Frequency** of **10 GHz**.
 - Set the **Maximum Number of Passes** to **8**. This setting gives the solver more tries to achieve convergence.

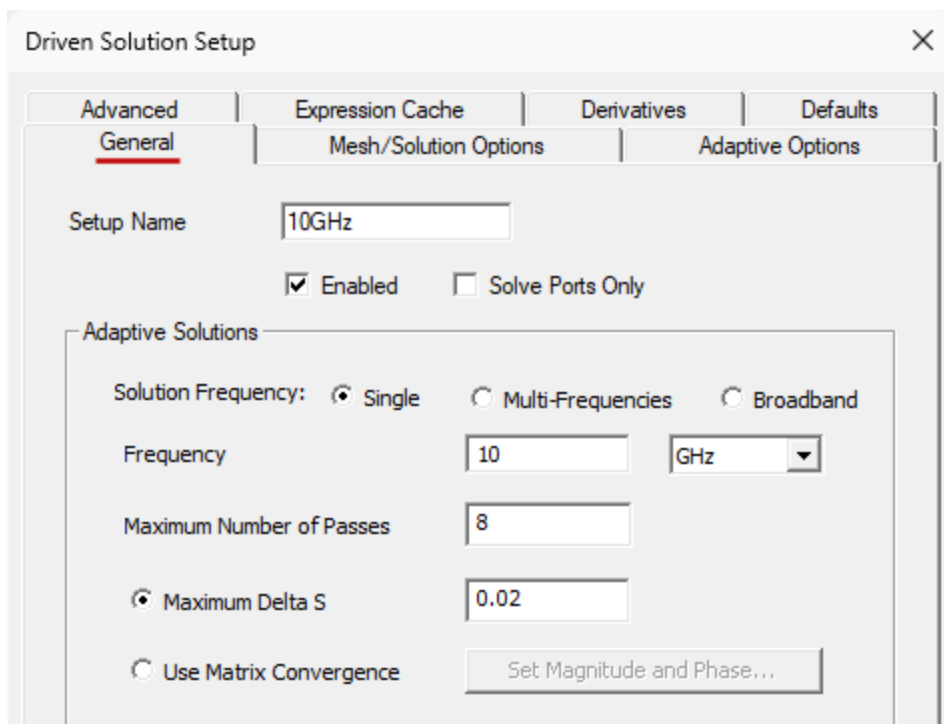

3. Click **OK** to close the *Driven Solution Setup* dialog box.

Since the HFSS design already contains a port assignment, the *Edit Frequency Sweep* dialog box opens automatically.

4. Rename the sweep and define a linear step, interpolating sweep from 8 GHz to 12 GHz with a step size of 0.01 GHz. Do so by setting the options in the **General** tab of the *Edit Frequency Sweep* dialog box as shown below:

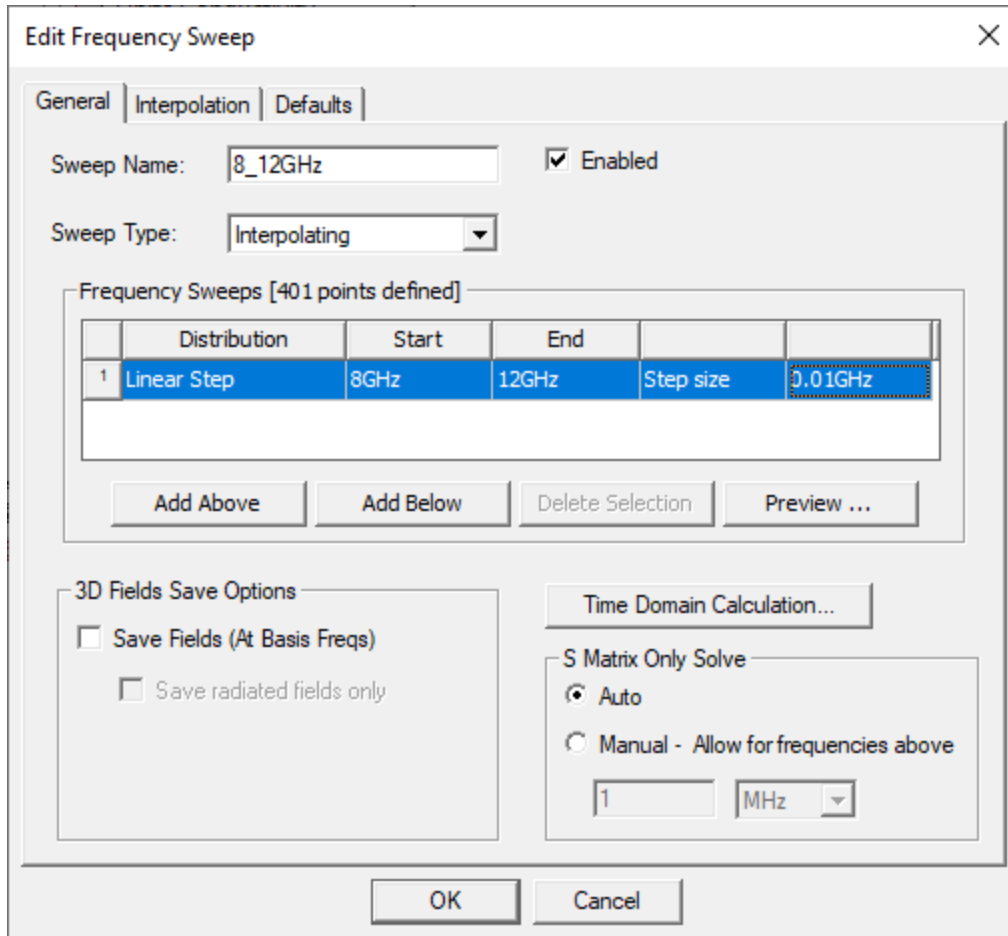

5. Click **OK**.

At this stage, all required simulation setups are defined.

Create Open Region

In this section you will see how to create an open region automatically based on the operating frequency.

1. Right-click anywhere in the modeler window and select **Create Open Region** from the short-cut menu.

Note:

Observe that the *Operating Frequency* is automatically set to 10 GHz, since you already defined the solution frequency in the Driven Solution Setup.

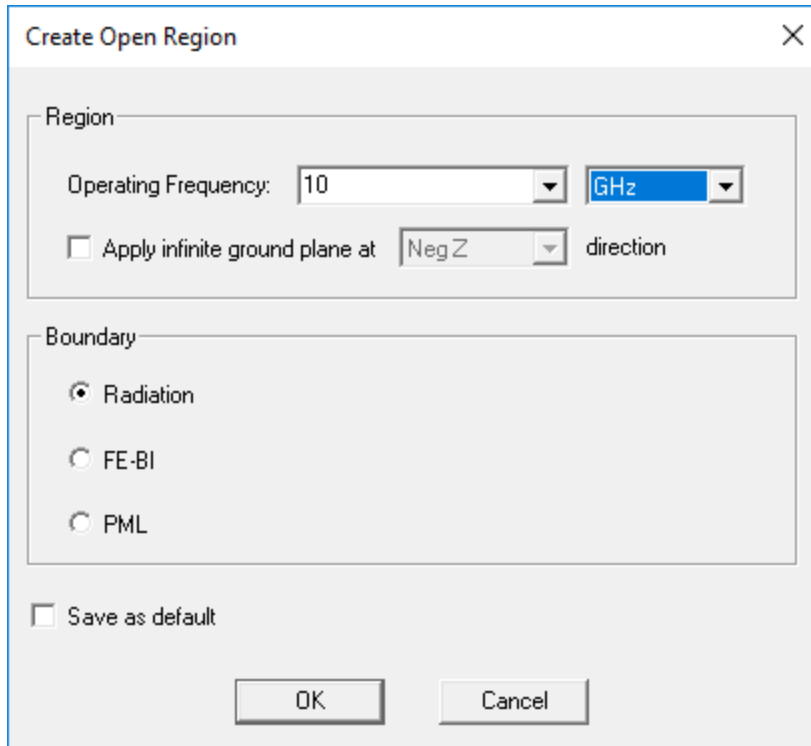

2. Ensure **Boundary** is set to **Radiation** and click **OK**.
3. Under *Boundaries* in the Project Manager, select **Open1** to see the open region visualization (if it isn't already displayed).

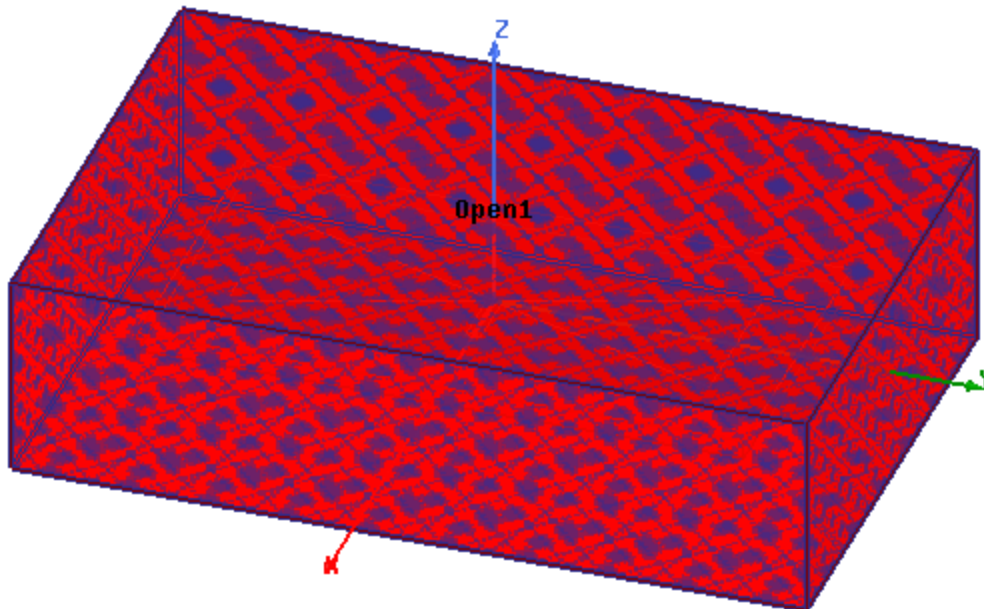

4. Click in the Modeler window background area to clear the selection. Your model should look like the following figure:

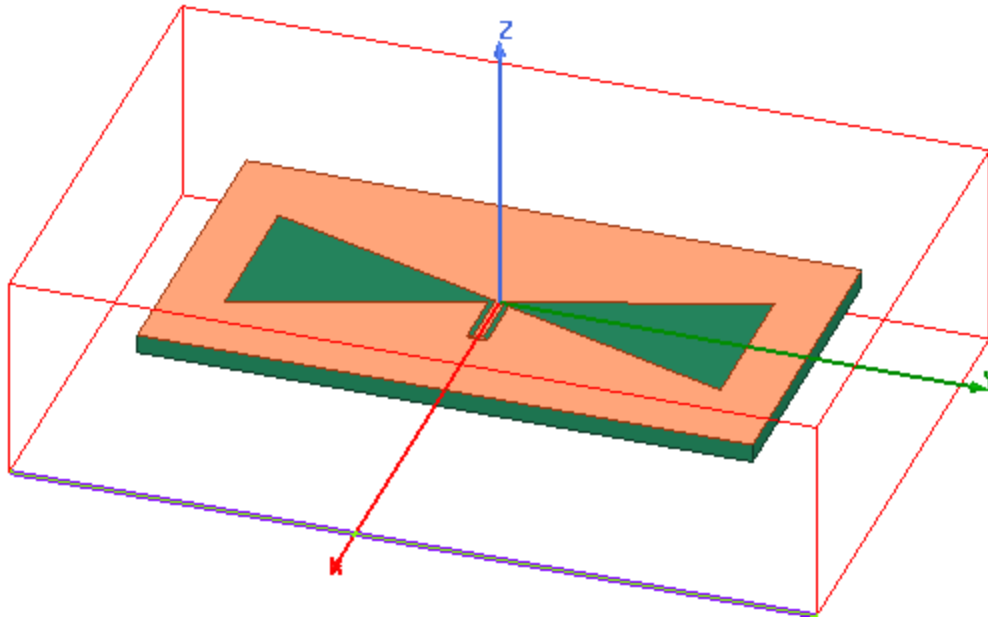

Parametrization and Analysis

Up to now, you saw how to leverage the features of the History Tree and its ability to track and manage different Modeler commands. Think of the History Tree as if it were a "programming language" to design the antenna parametrically, instead of designing it in a "linear" fashion. Since the objects that make up the antenna were designed parametrically, changing the value of any variable causes the entire downstream geometry to update accordingly. For example, if you vary the values of *FlareLength*, the rest of the geometry tracks with that change. For now retain the current values of the variables except for the *FeedInset*, which you will change.

Change the Field Inset

Complete the following steps to vary the *FeedInset* value.

1. Select **HFSSDesign1 (DrivenModal)** in the *Project Manager*.

All variables and their corresponding values are now displayed in the docked *Properties* window.

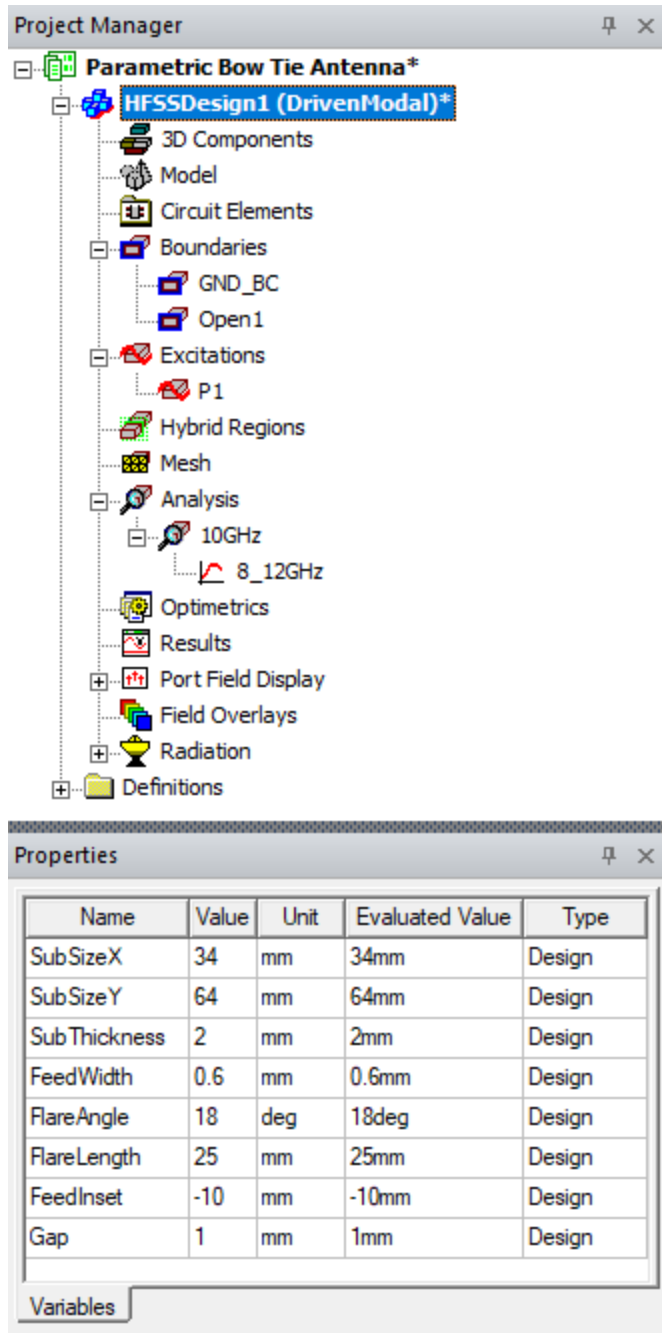

The screenshot displays the Project Manager and Properties windows in HFSS. The Project Manager window shows a tree view for 'Parametric Bow Tie Antenna*' with 'HFSSDesign1 (DrivenModal)*' selected. The Properties window shows a table of design variables.

Name	Value	Unit	Evaluated Value	Type
SubSizeX	34	mm	34mm	Design
SubSizeY	64	mm	64mm	Design
SubThickness	2	mm	2mm	Design
FeedWidth	0.6	mm	0.6mm	Design
FlareAngle	18	deg	18deg	Design
FlareLength	25	mm	25mm	Design
FeedInset	-10	mm	-10mm	Design
Gap	1	mm	1mm	Design

2. Change the value of the **FeedInset** variable from -10 mm to **-7 mm** and press **Enter**.

Name	Value	Unit	Evaluated Value	Type
SubSizeX	34	mm	34mm	Design
SubSizeY	64	mm	64mm	Design
SubThick...	2	mm	2mm	Design
FeedWidth	0.6	mm	0.6mm	Design
Gap	1	mm	1mm	Design
FlareAngle	18	deg	18deg	Design
FlareLength	25	mm	25mm	Design
FeedInset	-7	mm	-7mm	Design

Due to intrinsic parametrization, all the objects that make up the geometry track with the newly defined *FeedInset* value of -7 mm.

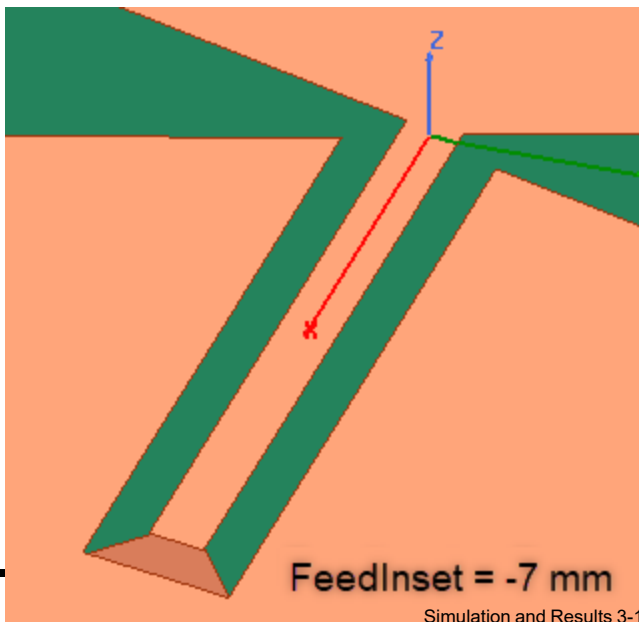
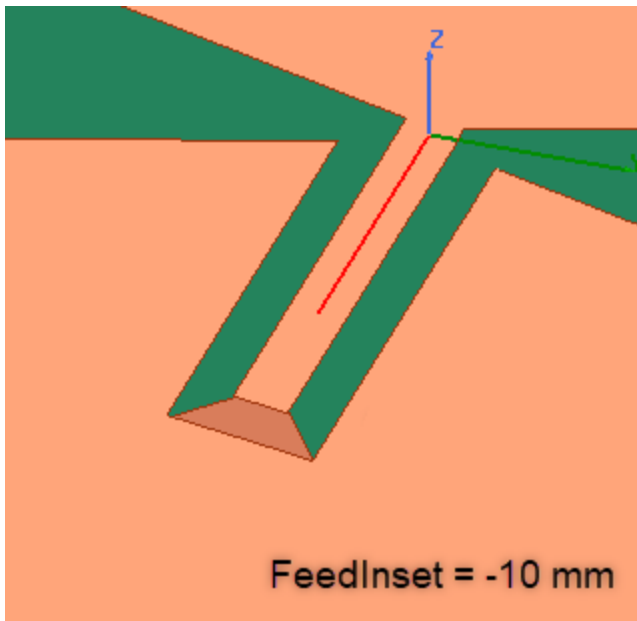

Note:

You may want to experiment and observe the effects of changing other parameters, such as the FlareAngle, FeedWidth, or Gap. Feel free to do so but return all parameters to the values shown in the figure immediately below step 2 before proceeding with the rest of the tutorial.

Validate the Simulation Setup

Next, ensure that all aspects of the simulation setup are properly defined.

- On the **Simulation** ribbon tab, click  **Validate**.

Make sure that all phases of the validation check pass, as shown below:

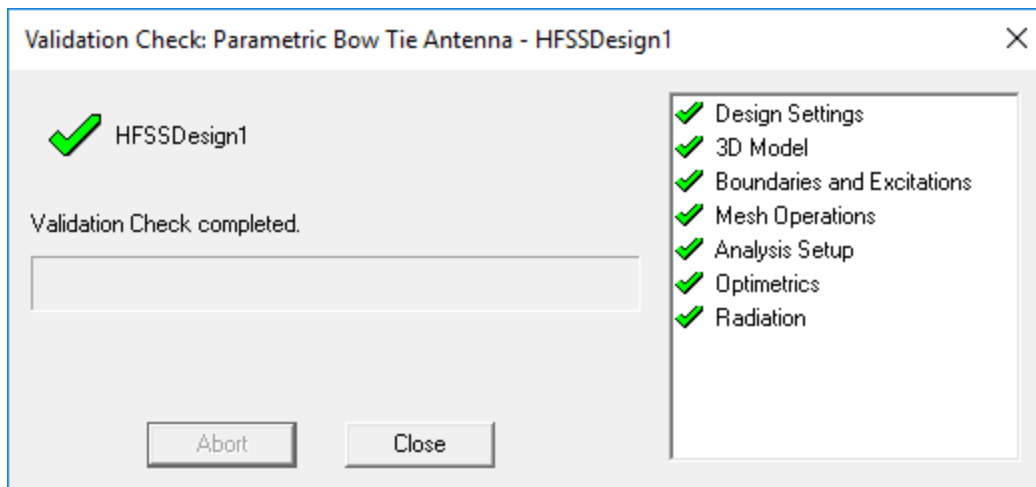

- Click **Close**.

Run the Analysis

Finally, solve the model. In the sections that follow, you will evaluate the results.

- In the **Simulation** ribbon tab, click  **Analyze All** to start the solution process.

Define Far Field Setups

This section shows how to define far field setups before generating the radiation pattern. For the radiation boundary you used the **Create Open Region** command. In addition to the open region this command also automatically produces sample far field setups (**3D**, **Azimuth**, and **Elevation**) under the **Radiation** option in the *Project Manager* window. You can double-click

each of these setups and use the predefined values of **Start**, **Stop** and **Step Size** for **Phi** and **Theta** or change these values as desired. The steps are as follows.

1. Double-click **3D** under **Radiation** in the Project Manager.

The *Far Field Radiation Sphere Setup* dialog box opens.

2. For **Phi**, define the **Start**, **Stop**, and **Step Size** fields to be **-180 deg**, **180 deg**, and **1 deg**, respectively.
3. For **Theta**, define the **Start**, **Stop**, and **Step Size** fields to be **0 deg**, **180 deg**, and **1 deg**, respectively.

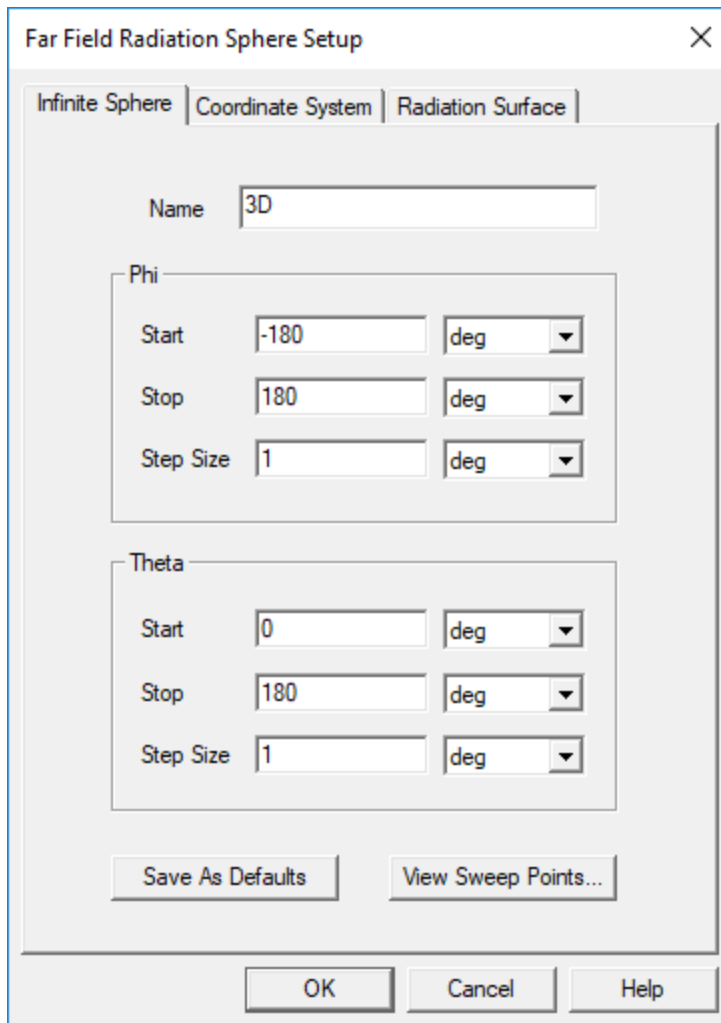

4. Click **OK**.
5. Again, under **Radiation** in the Project Manager, double-click **Elevation**.
The corresponding *Far Field Radiation Sphere Setup* dialog box appears.
6. Change the **Name** of this setup to **Principle Plane**.

The predefined **Start**, **Stop**, and **Step Size** values for **Phi** are *0 deg*, *90 deg*, and *90 deg*, respectively.

The predefined **Start**, **Stop**, and **Step Size** values for **Theta** are *-180 deg*, *180 deg*, and *1 deg*, respectively.

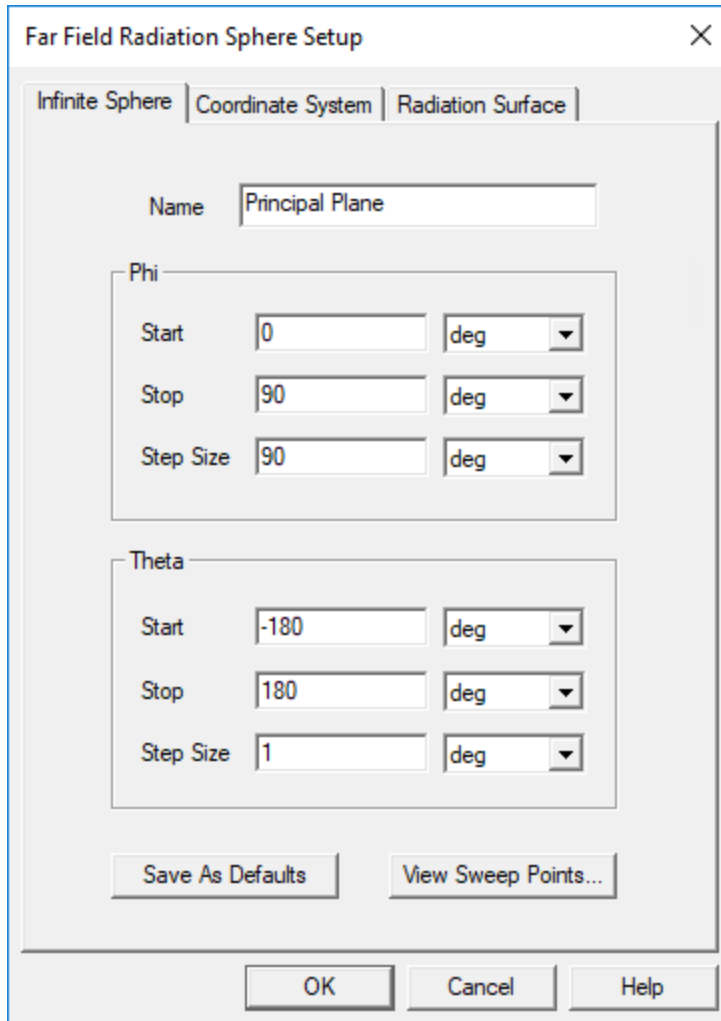

7. Accept the predefined *Phi* and *Theta* values and click **OK**.

Note:

As an alternative method of creating a new far field radiation setup, right-click **Radiation** and select **Insert Far Field Setup > Infinite Sphere**. Enter the desired values for *Phi* and *Theta* and click **OK**. Editing the readily available sample setups is easier than using this manual process of creating a far field setup.

Create S Parameter Plot

Create the S-parameter plot as follows.

1. In the Project Manager, right-click **Results** and select **Create Modal Solution Data Report > Rectangular Plot**.
2. Ensure that **10GHz : 8_12GHz** is selected from the **Solution** drop-down menu and **Sweep** from the **Domain** drop-down menu.
3. Ensure that **S Parameter** is selected in the **Category** list, **S(P1,P1)** as the **Quantity**, and **dB** as the **Function**.
4. Select the **Real time** option under *Update Report*.

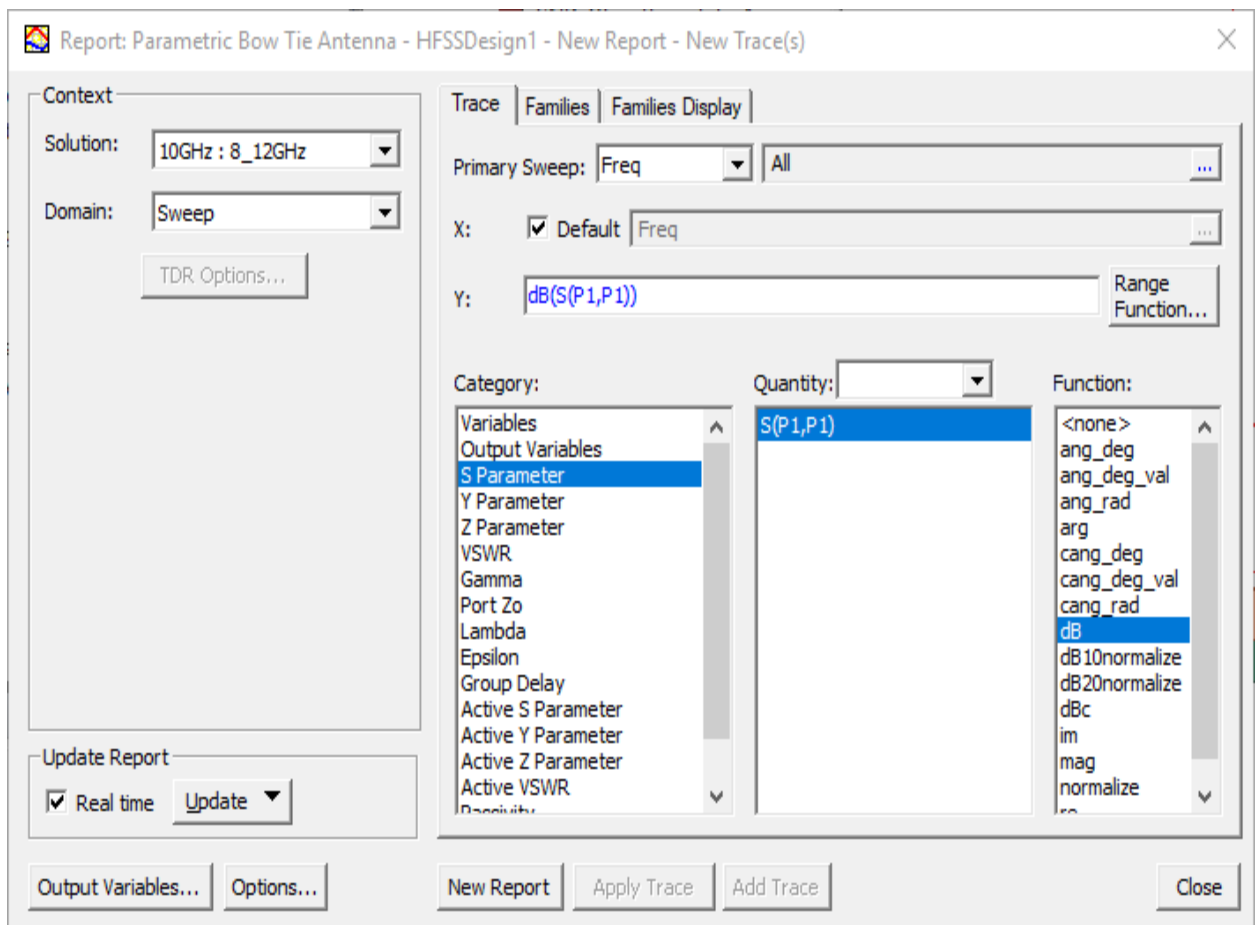

5. Click **New Report** and click **Close**.

The S 11 plot is generated.

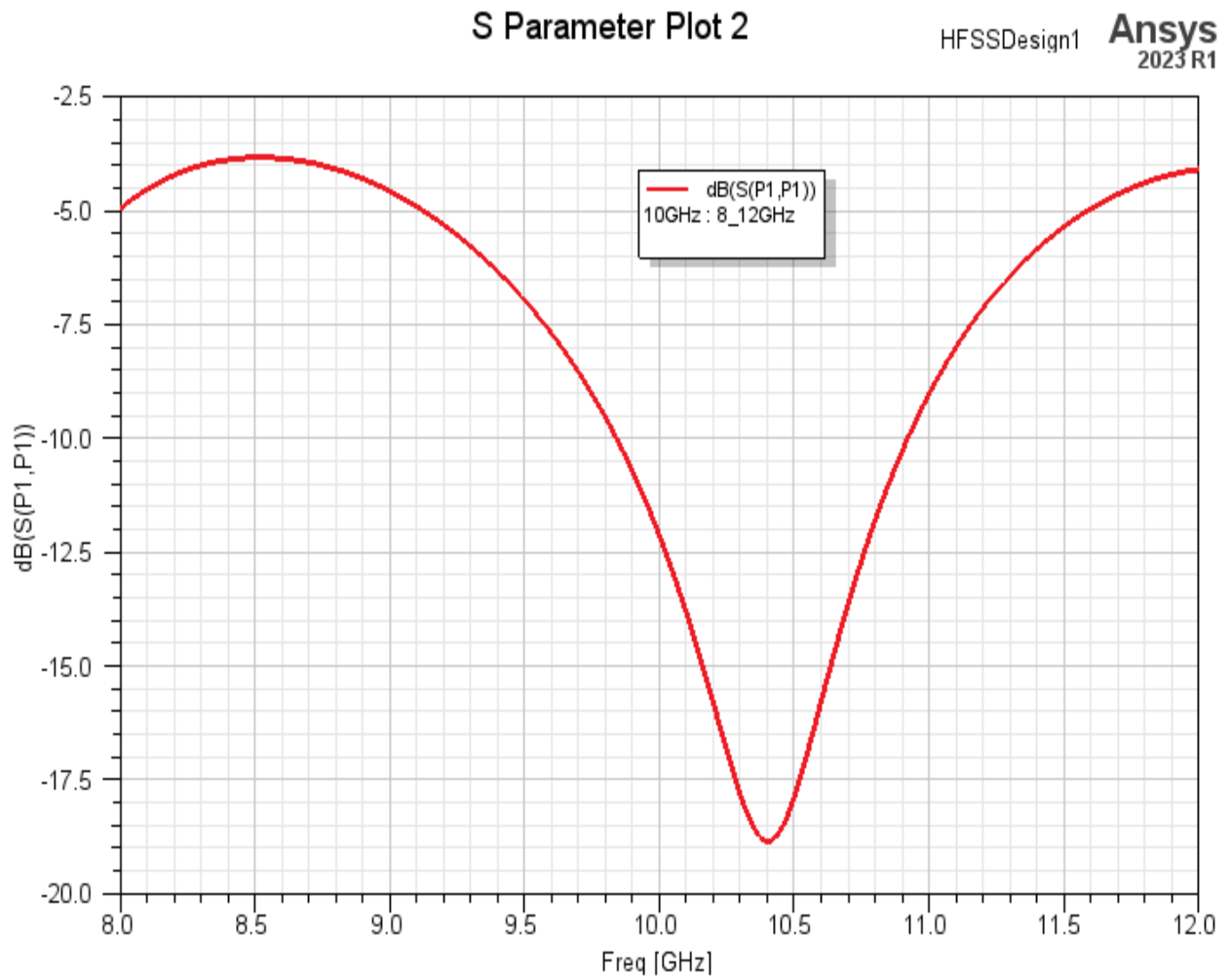

Create Z Matrix Plot

Create the Z-parameter plot as follows.

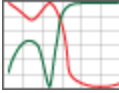
1. In the **Results** ribbon tab, select  **Modal Solution Data Report** >  **2D**.
2. Ensure that **10GHz : 8_12GHz** is selected from the **Solution** drop-down menu and **Sweep** from the **Domain** drop-down menu.
3. Select **Z Parameter** from the **Category** list and ensure that the **Quantity** is **Z(P1,P1)**.
4. From the **Function** list, click **im**, hold **Ctrl**, and click **re** to select both of these functions.

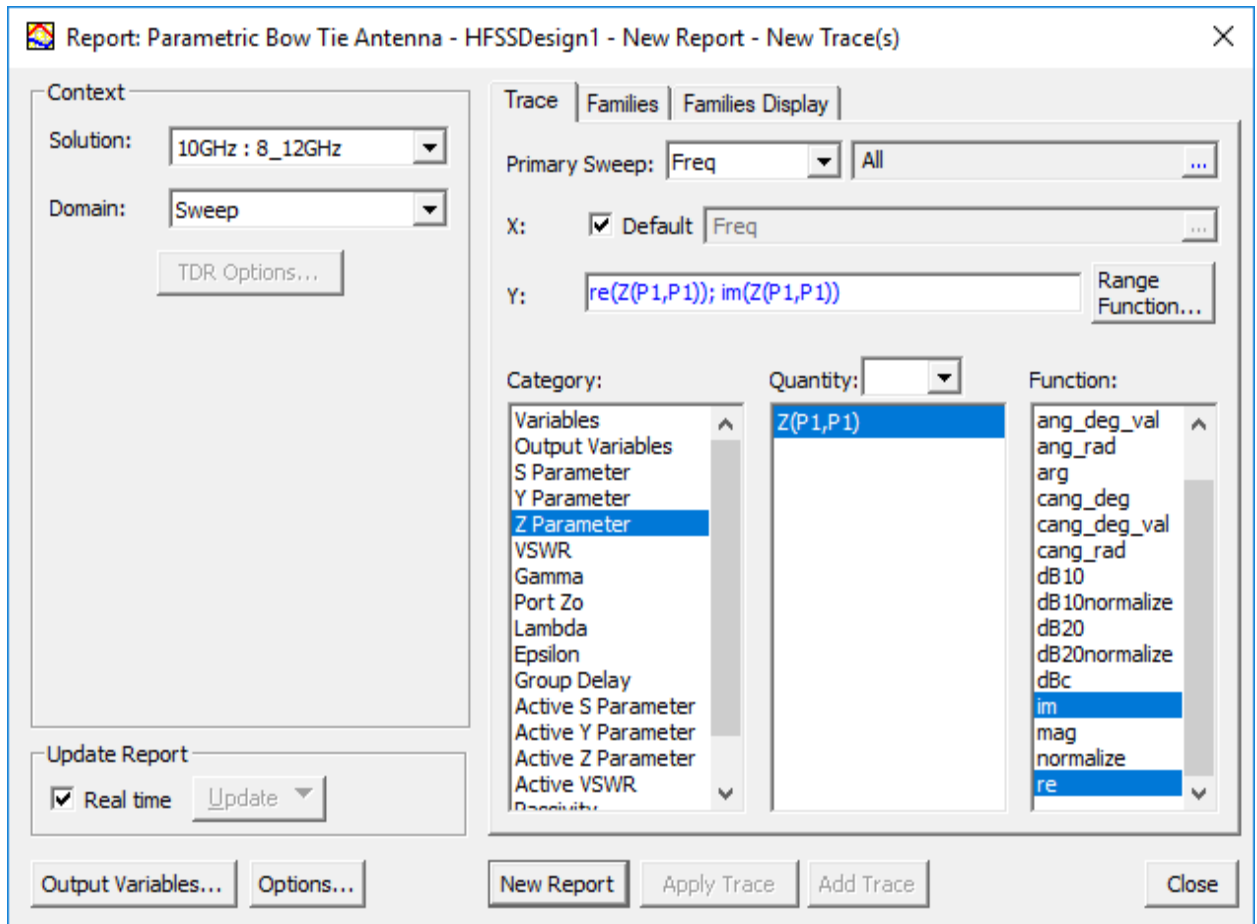

5. Click **New Report** and click **Close**.

The Z(P1,P1) plot is generated and contains two curves.

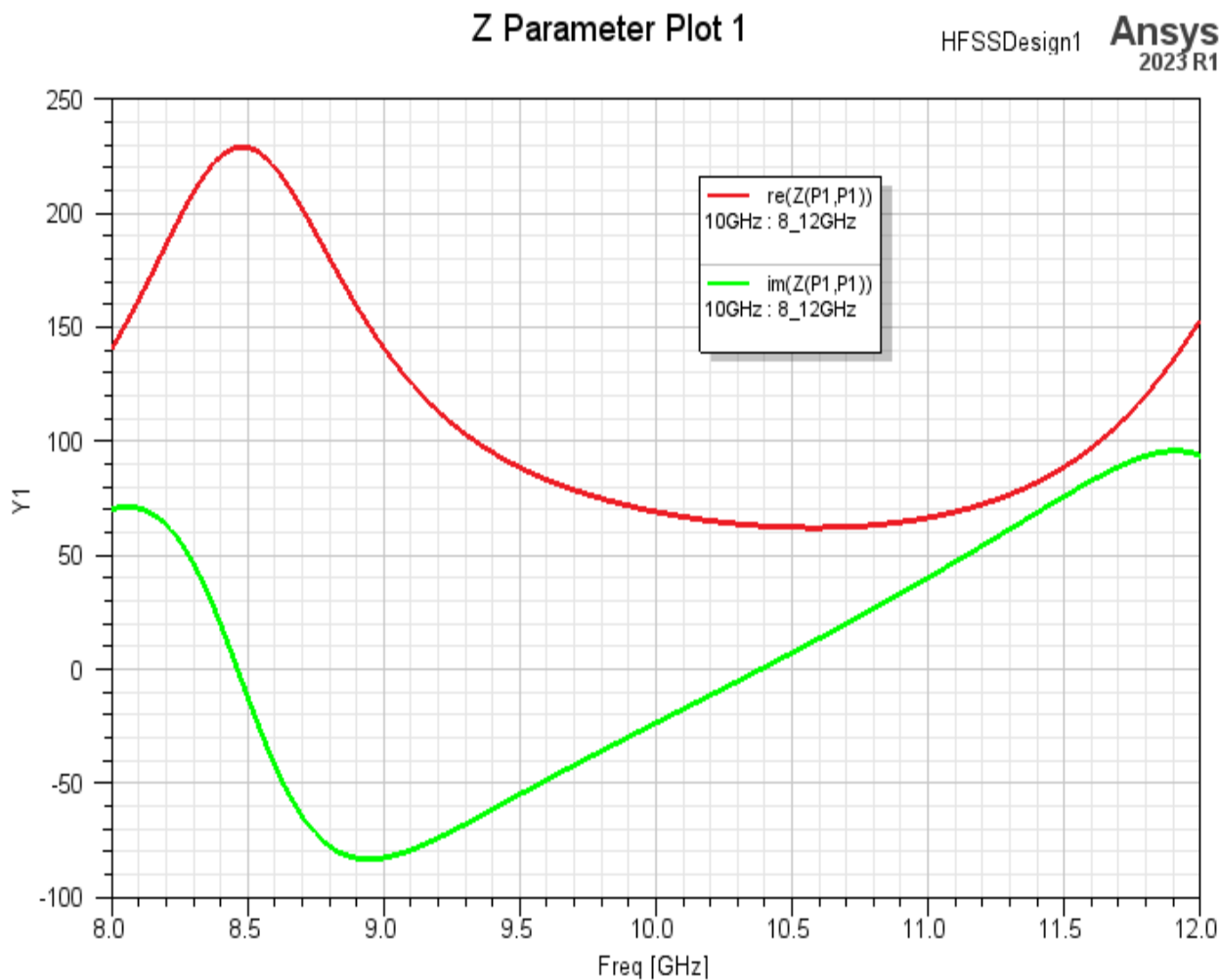

6. Under **Results > Z Parameter Plot 1** in the Project Manager, click **im(Z(P1,P1))**.
7. In the docked *Properties* window, select **Y2** from the **Y axis** drop down menu. This action creates unique vertical scale for each curve so that both curves fill the plot window height.

Click in the *Z Parameter Plot 1* window's background area to deselect the *im* curve.

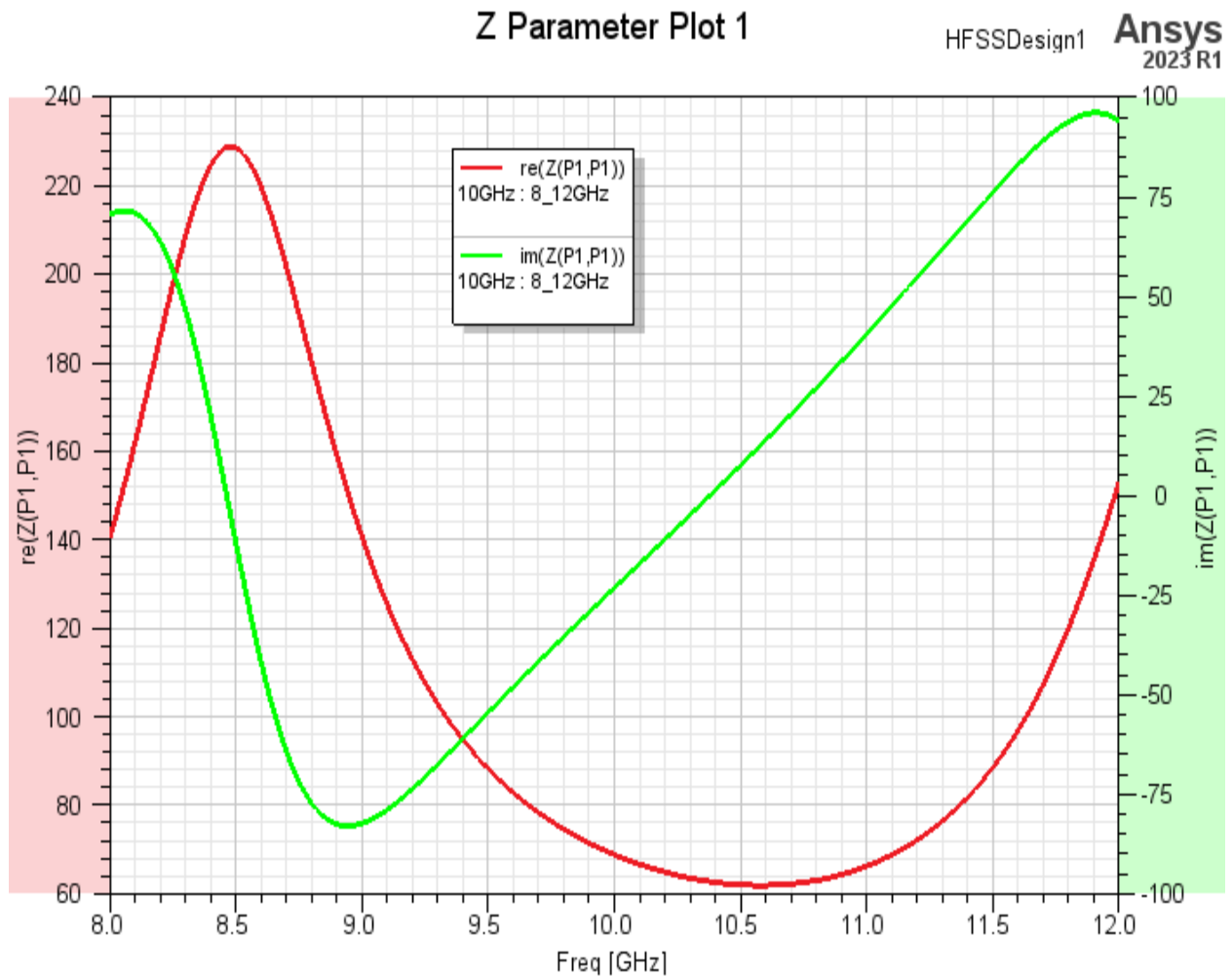

Create Far Field Pattern (3D Polar Plot)

This section shows how to create Far Field reports.

1. On the **Results** ribbon tab, click  **Far Fields Report** >  **3D Polar**.

The *Report* dialog box opens.

2. Ensure that **Geometry** is set to **3D**.
3. Under **Category** select **Gain**, under **Quantity** select **GainTotal**, and under **Function** select **dB**.

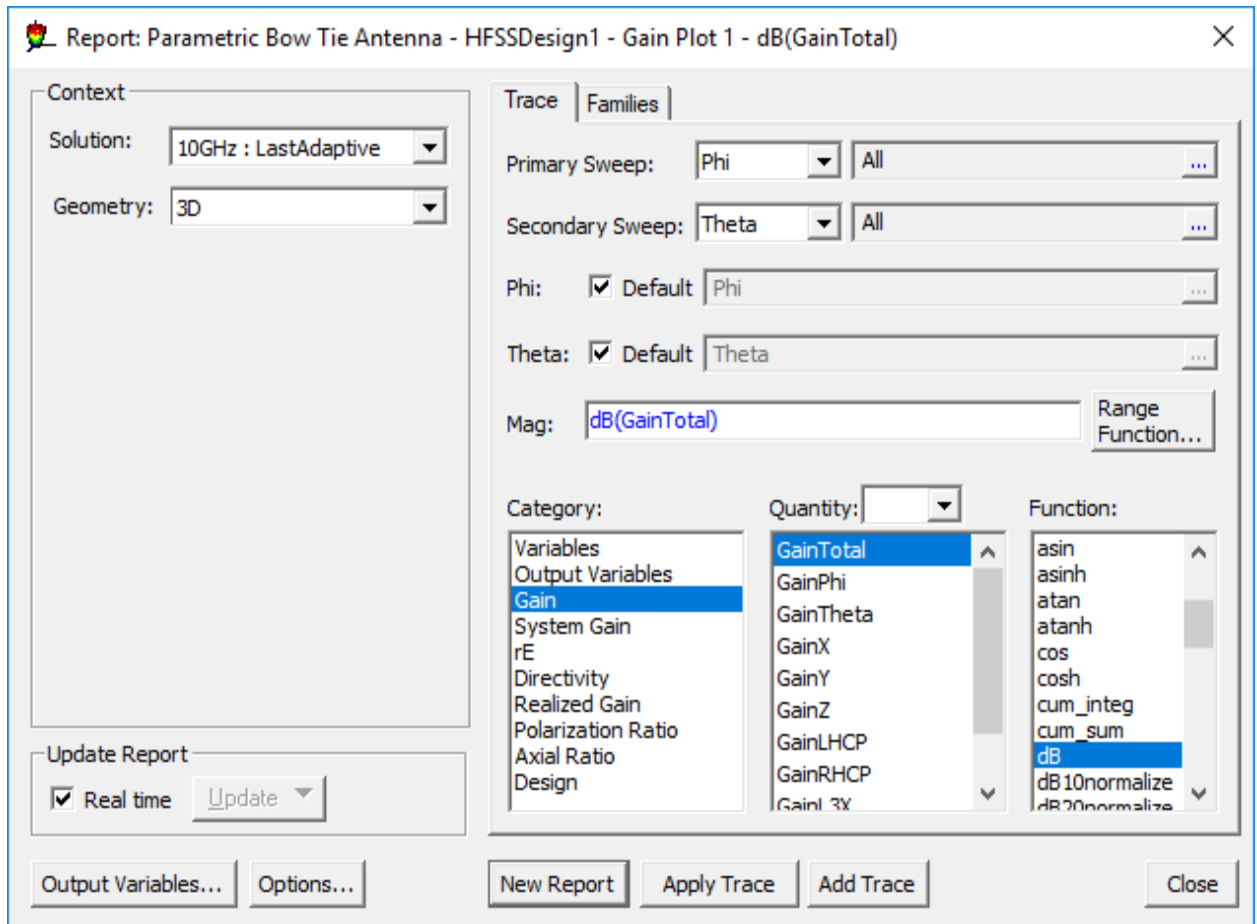

4. Click **New Report** and click **Close**.
5. Double-click inside the *Gain Plot 1* window.

The *Properties* dialog box opens.

6. Select the **Axis Phi** tab. Under *Scaling*, change **Num. Ticks** to **10**, and press **Enter**.
7. Select the **Axis Theta** tab. Under *Scaling*, change **Num. Ticks** to **12**, and press **Enter**.
8. Select the **Axis Rho** tab. Under *Scaling*, change **Num. Ticks** to **8**, and press **Enter**.
9. Click **OK** to apply the revised plot settings and close the dialog box.

1. Right-click **Results** in the Project Manager and choose **Create Far Fields Report > Radiation Pattern**.

The *Report* dialog box opens.

2. From the **Geometry** drop-down menu, select **Principle Plane**. Then, select the following items from their respective lists:
 - *Category*: **rE**
 - *Quantity*: **rETotal**
 - *Function*: **<none>**

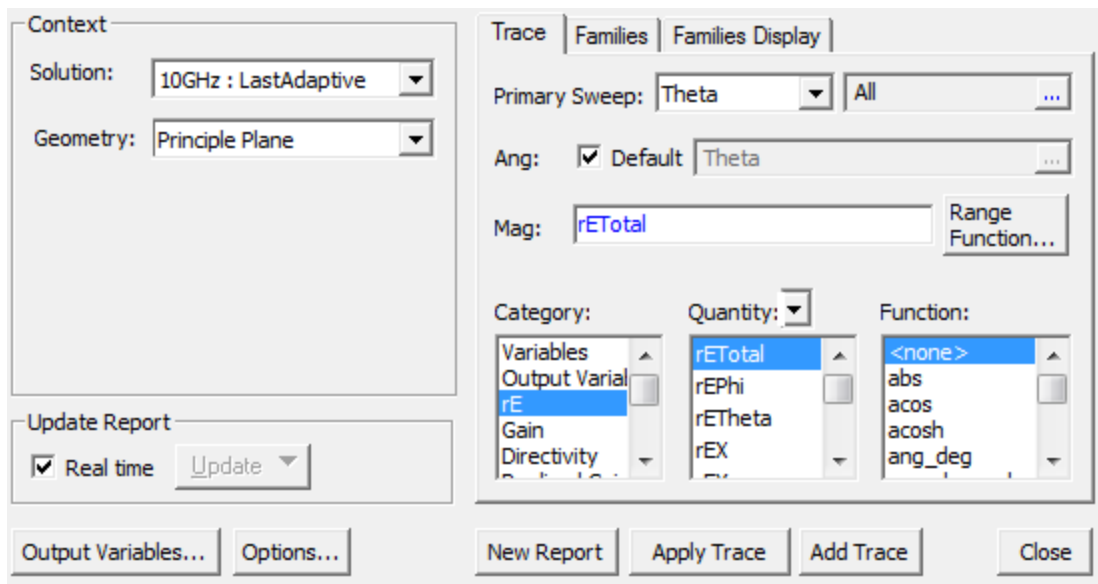

3. Click the **Families** tab. Then, click the **ellipsis** button (...) in the **Phi** row, click **Select values**, and select **0 deg**.

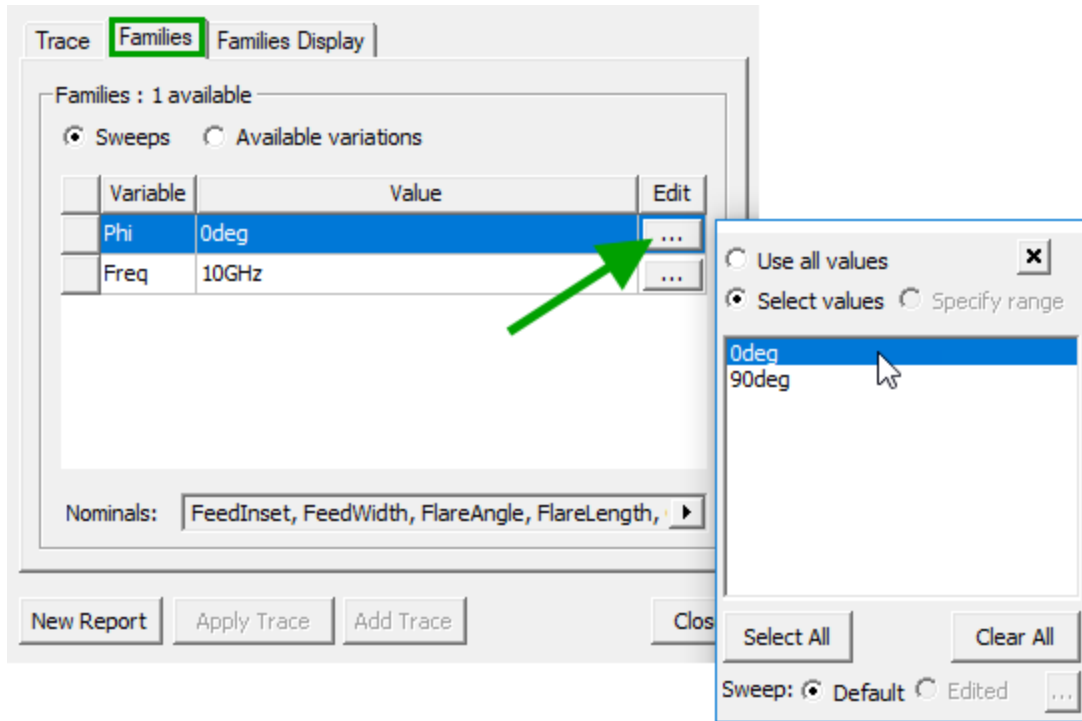

4. Click **New Report** but do *not* close the *Report* dialog box yet.

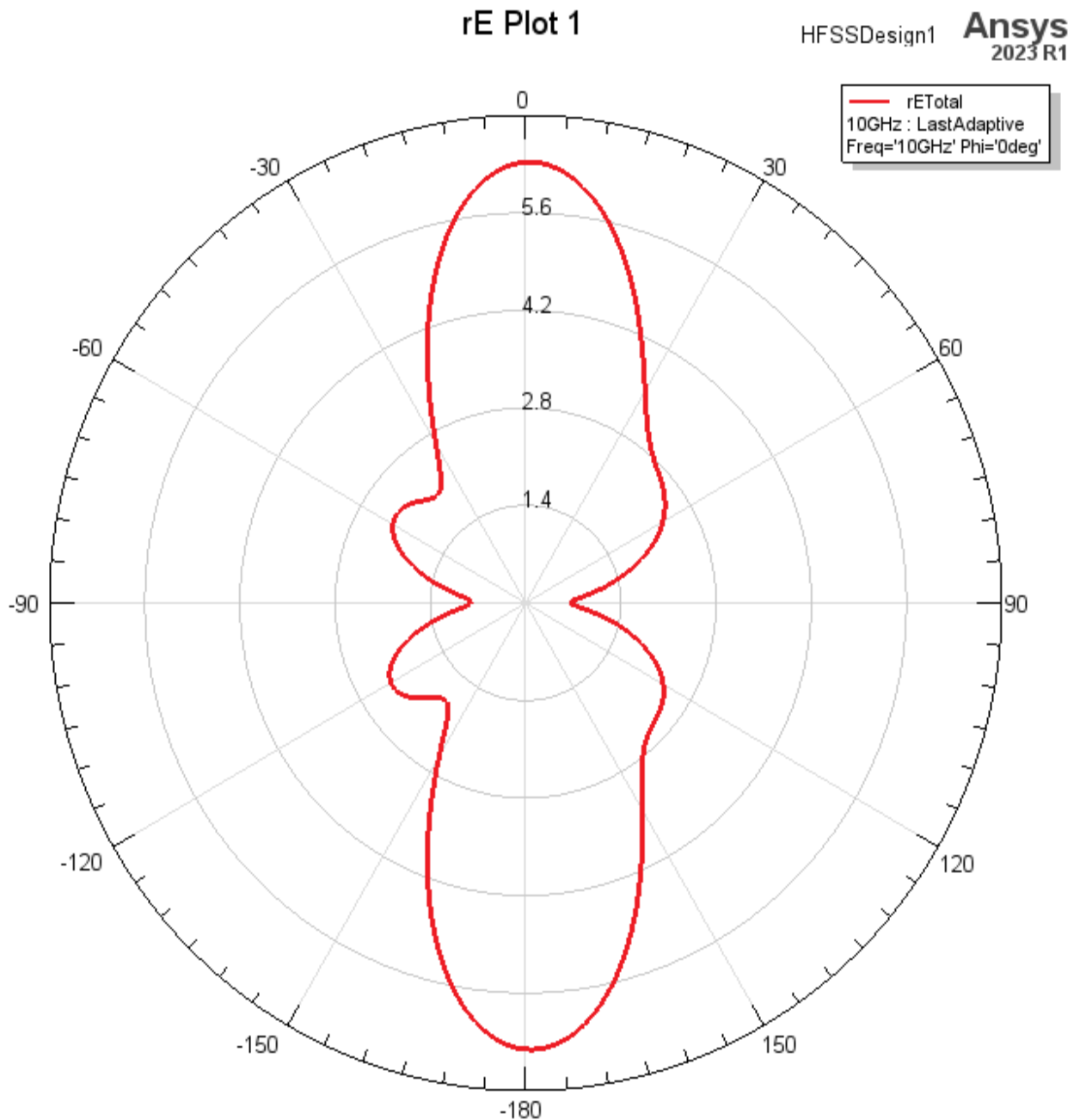

- Repeat steps 3 through 5 but, this time, select **90 deg** for **Phi**. After creating the second rE plot (via **New Report**), click **Close**.
- On **rE Plot 2**, click directly on the curve to display its properties in the docked *Properties* window. Then, click on the red **Color** sample in the *Value* column, choose a medium blue shade from the *Color* dialog box, and click **OK**.

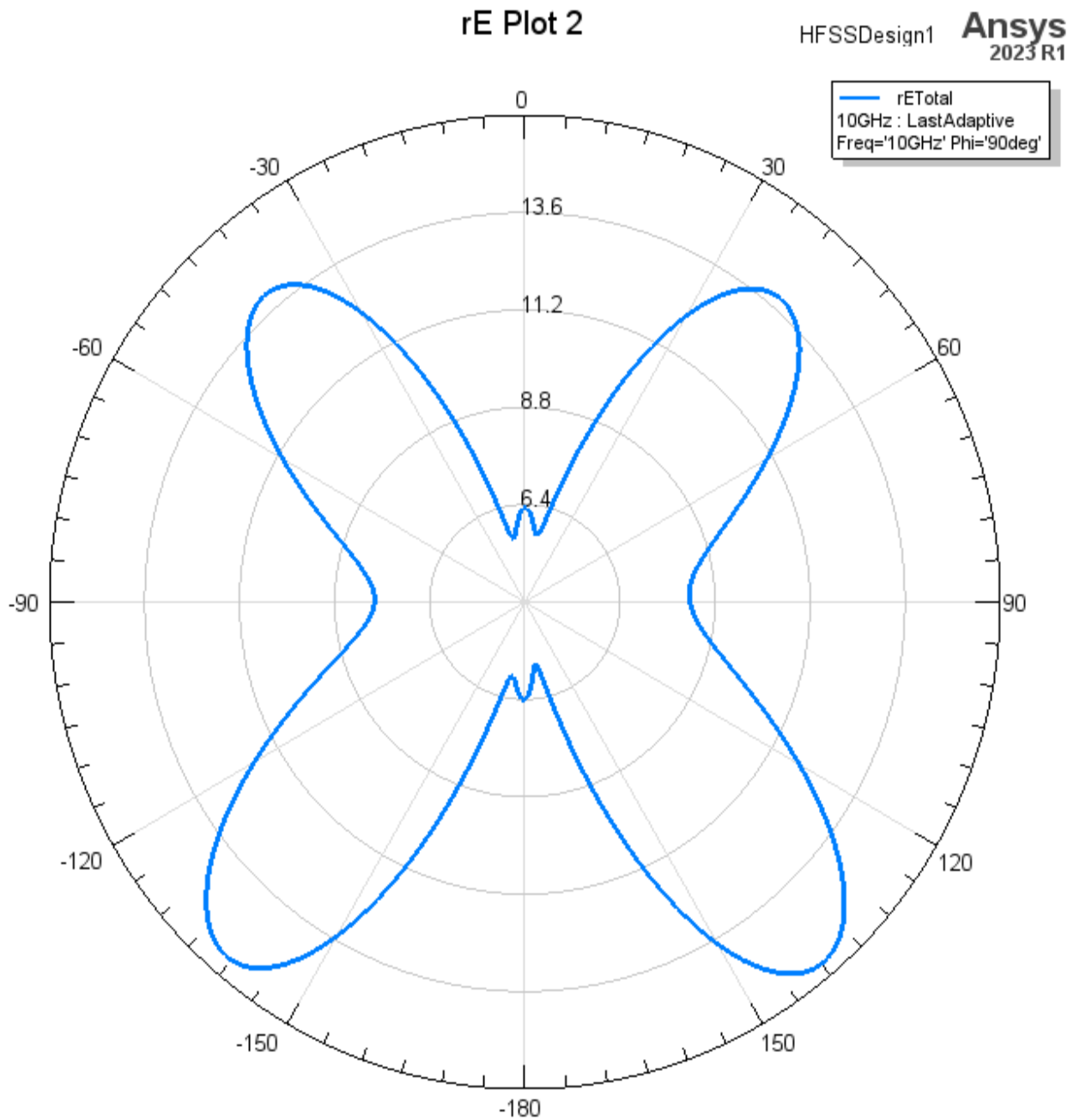

Note:

In the next procedure, you will overlay the two rE curves on the 3D gain plot. Changing the color of the second rE plot helps to differentiate the two curves.

Overlay Radiation Pattern

This section shows how to overlay radiation pattern on the antenna geometry.

1. Make the Modeler window active again. You can use the options in the *Window* menu to arrange, select, or close the various plot and modeler windows.
2. In the History Tree, under **Solids** > **vacuum**, right-click **Radiating Surface** and choose **View** > **Hide In Active View** from the shortcut menu.
3. Right-click anywhere in the *Modeler* window and choose **Plot Fields** > **Radiation Field** from the short-cut menu.

The *Overlay radiation field* dialog box appears.

4. Edit the different fields in this dialog box as shown in the following figure:

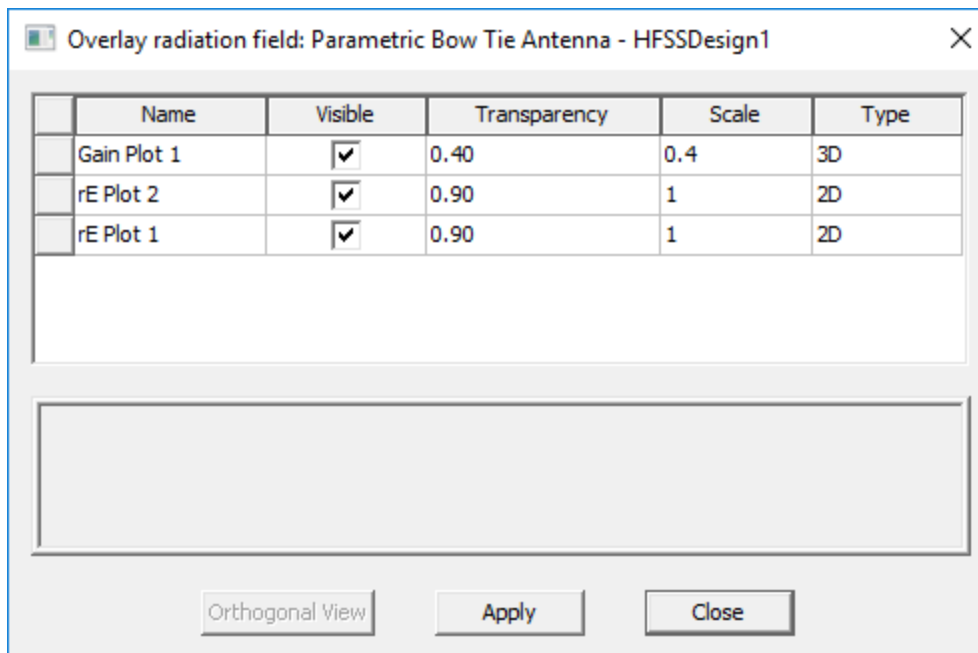

5. Click **Apply** and click **Close**.

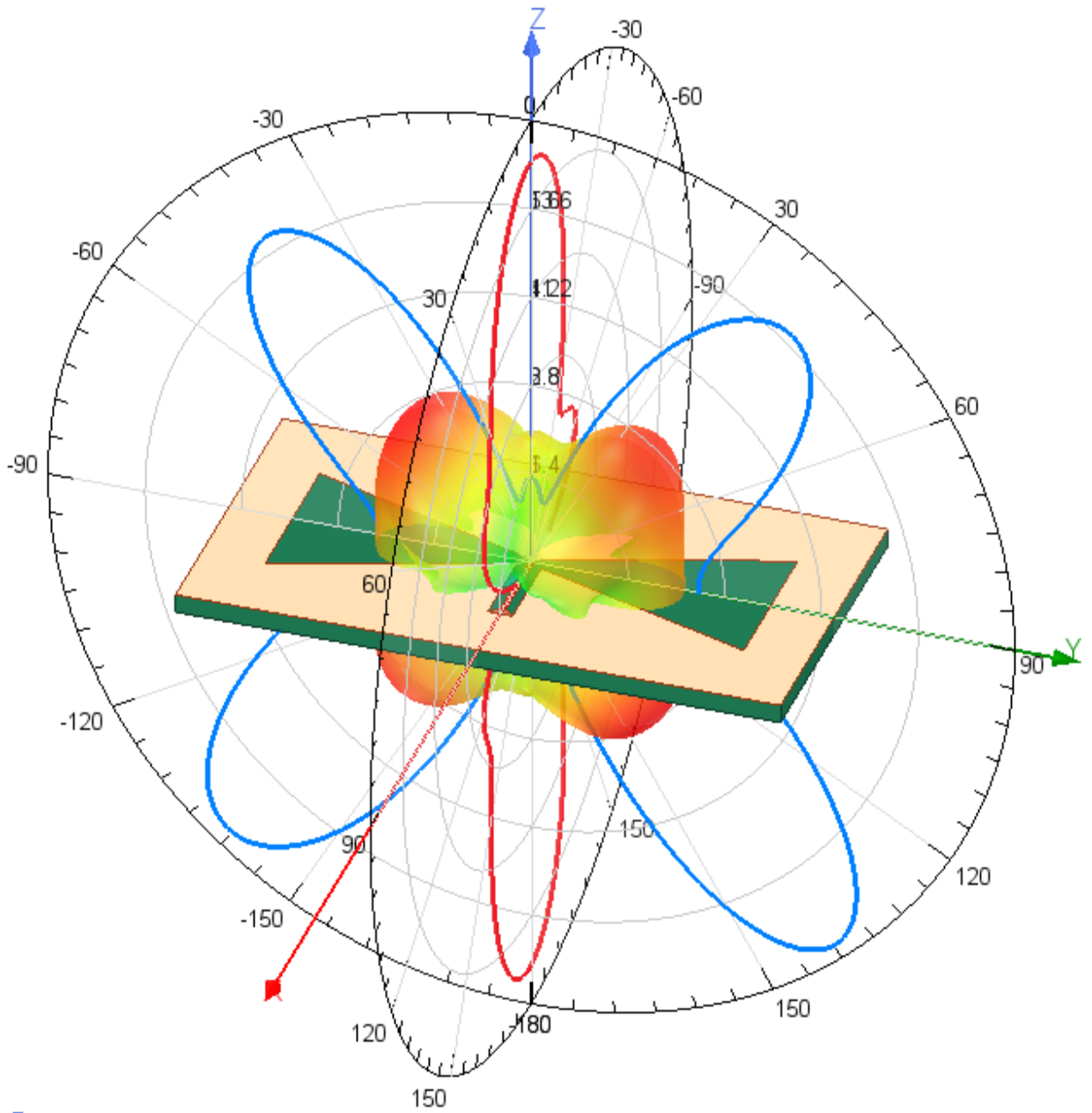

7

The preceding figure shows the default Trimetric view orientation. Size and orient your view as desired.

Observations:

By carefully studying these field overlays, we can make several conclusions regarding the behavior of this bow tie antenna:

- Consider a vector in the global XZ plane anchored at the origin. Look at the way the radiated electric field (as represented by the red curve) varies as you rotate this vector about the global Y axis. As you might intuitively expect, the electric field strength is greatest when the plane of the antenna is perpendicular to the vector and is nearly zero when the plane of the antenna is parallel to the vector.
- Now, consider a vector in the global YZ plane anchored at the origin. Look at the way the radiated electric field strength (as represented by the blue curve) varies as you rotate this vector about the global X axis. You may find it surprising that the greatest electric field strength is *not* obtained when the plane of the antenna is perpendicular to the vector. Rather, the greatest electric field strength occurs when the vector is approximately 40 degrees off of the perpendicular direction. This behavior is true for positive and negative 40 degrees and for the front and back of the antenna alike. The electric field strength is relatively low when the vector is parallel to the plane of the antenna and very low when perpendicular to the plane of the antenna.
- Based on the first two observations, we can safely conclude that the best performance of this antenna will be experienced when the following conditions exist:
 - The plane of the bow tie antenna with regard to X rotation is +40 degrees or -40 degrees off of perpendicular to the line connecting the transmitter and receiver. (In other words, The X rotation angle = +40, -40, +140, or -140 degrees, as indicated on the preceding overlay plot.)
 - The plane of the bow tie antenna with regard to Y rotation is perpendicular to the line connecting the transmitter and receiver. (In other words, the Y rotation angle = 0 or +/- 180 degrees, as indicated on the preceding overlay plot.)

Note:

These observations assume that no land formations or structures interfere by reflecting or diffusing the radiated energy.

Overlay Visibility

The previous section showed you the legacy method of applying a radiation pattern overlay on the geometry in the Modeler window.

This section shows another way to overlay radiation patterns on the antenna geometry. You can overlay 2D radiation patterns and 3D far field plots on the geometry directly from the Project Manager.

1. Right-click one of the applicable plots under *Results* in the *Project Manager* (for this example, **rE Plot 1**, **rE Plot 2**, or **Gain Plot 1**). Then, from the shortcut menu, toggle the **Show in Modeler Window** option to add or remove the plot overlay.
2. As in the prior section, right-click in the *Modeler* window and select **Plot Fields > Radiation Fields** to access the *Overlay Radiation Field* dialog box. You will need to use this dialog box to adjust the transparency and scale settings for the individual plot overlays.

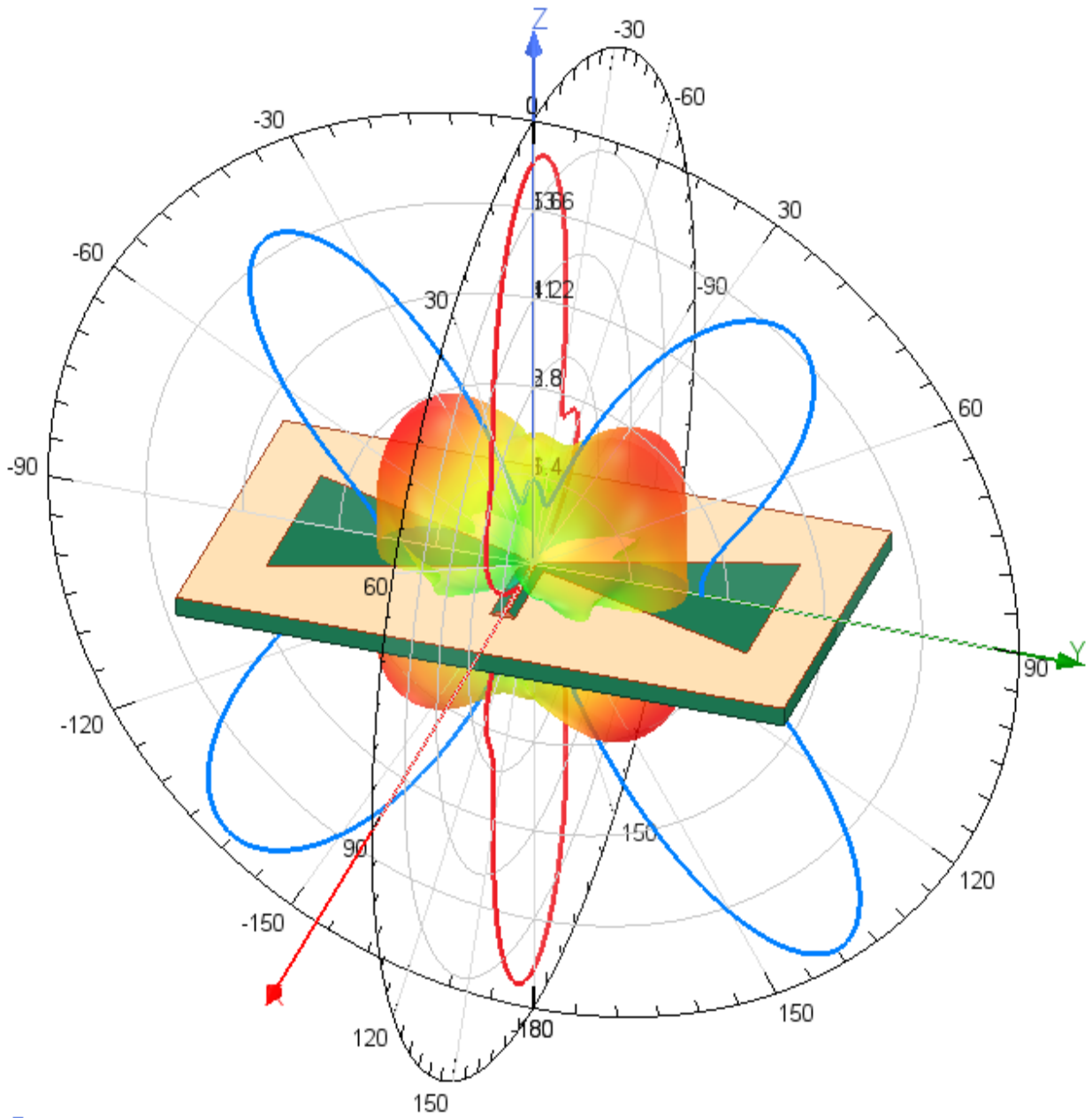

Note:
For more information see the *Overlay Visibility* section in the HFSS help.

3.  **Save** your project.

You have completed the parametric version of the bow tie antenna. You can close this project now. In the next section, you will create the bow tie antenna using a linear, non-parametric method.

4 - Linear Method Of Creating The Bow Tie Antenna

This tutorial is intended to show you how to create, set up, and analyze a Coplanar Waveguide-Fed Bowtie antenna in a "linear" fashion in HFSS. In this method we employ typical modeling practices for creating and solving designs in HFSS. Some of the operations include the following:

- Creating the 3D Model in a "Linear" Fashion
- Defining Boundary Conditions
- Assigning Excitations
- Specifying Adaptive Frequency
- Running the Simulation
- Performing Post Processing

Initial Preparation

Before starting to create the 3D geometry using a typical linear workflow, perform the following preliminary steps:

1. Launch Ansys Electronics Desktop and insert an HFSS design into a new project. If you need a reminder of how to do that, refer to the [Insert HFSS Design Type](#) page from the *Overview and Initial Setup* section of this guide.
2. In the Project Manager, right-click the default project name (**Projectx**) and rename it **Bow Tie Antenna (Linear Method)**.
3. If you have not completed the steps outlined in the [Set Up General Options](#) page of the *Overview and Initial Setup* section, or if you've changed your general options since doing so, complete the instructions on that page before proceeding further. The instructions in this section are consistent with the program behavior obtained using the specified general options.
4. If your current unit of length is not defined as mm, change it now, as follows:
 - a. From the menu bar, click **Modeler > Units**. The *Set Model Units and Max Extent* dialog box appears.
 - b. Choose **mm** from the **Select Units** drop-down menu.

Keep the **Rescale to new units** and **Advanced** options cleared.

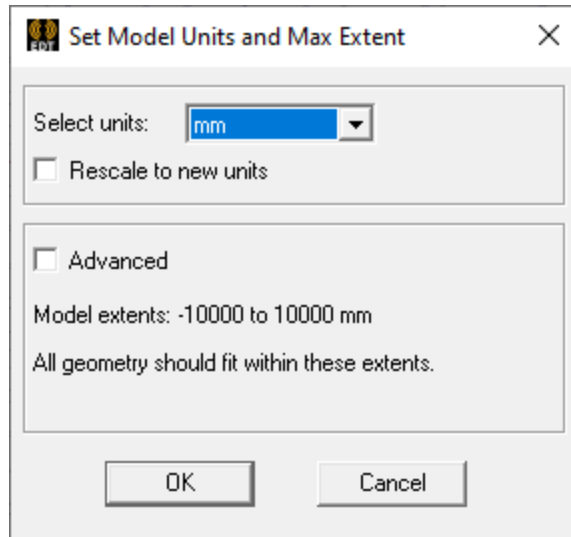

c. Click **OK**.

Set the type of solution to Modal and enable the *Auto-Open Region* option as follows:

5. Click **HFSS > Solution Type**. The *Solution Type* dialog box appears.
6. Select **Modal** under *Solution Types*.
7. Select **Auto-Open Region** and **Radiation** under *Driven Options*.

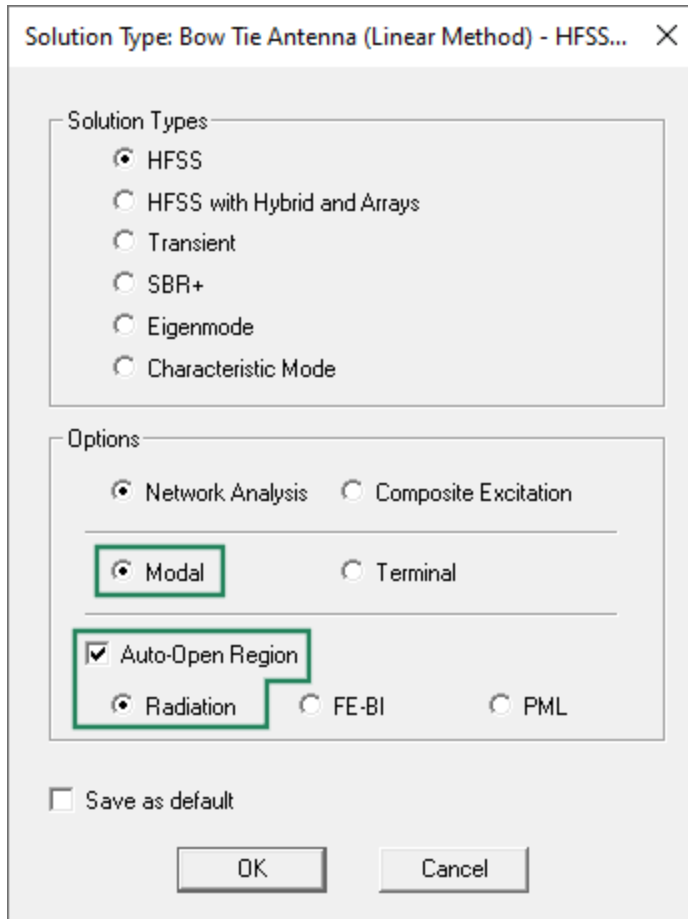

8. Click **OK**.

Draw Substrate

Use the *Box* primitive to draw the substrate and then edit its location and dimensions, as follows:

1. From the **Draw** ribbon tab, click  **Draw box**.
2. Press **F3** to ensure that you are in the graphical input mode.
3. Click anywhere in the *Modeler* window, move the mouse, and click a second time to create the base.
4. Move the mouse upward and click a third time to define the height.

These operations create a box of random size. Immediately after the third click, the *Properties* dialog box opens automatically (due to the setting defined in [Step 5 of the Set Up General Options](#) page). The next step is to specify the correct coordinates and dimensions in the *Properties* dialog box.

5. In the **Command** tab of the *Properties* dialog box, enter the following values (all inputs in mm):

- a. *Position*: **-17, -32, 0**
- b. *XSize*: **34**
- c. *YSize*: **64**
- d. *ZSize*: **-2**

The dialog box should be exactly as shown in the following figure:

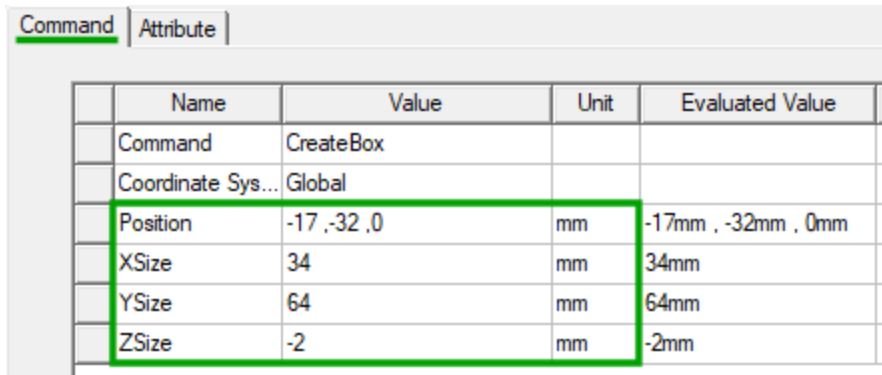

Command		Attribute		
Name	Value	Unit	Evaluated Value	
Command	CreateBox			
Coordinate Sys...	Global			
Position	-17 , -32 , 0	mm	-17mm , -32mm , 0mm	
XSize	34	mm	34mm	
YSize	64	mm	64mm	
ZSize	-2	mm	-2mm	

The specified dimensions and coordinates place the centroid of the top face at the global origin.

Do *not* close the *Properties* dialog box yet. You will next modify the object attributes (name and material).

6. Click on the **Attributes** tab of the *Properties* dialog box.
7. Change the **Name** of the box to **Substrate**.
8. From the drop-down menu in the **Material** value column, select **Edit**.
9. In the *Select Definition* dialog box, type in **Arlon** in the **Search** field.
10. Scroll down in the material list, select **Arlon CuClad 217 (tm)**.
11. Click **OK** twice to close the *Select Definition* and *Properties* dialog boxes.
12. Press **Ctrl + D** to fit the substrate to the Modeler window.
13. Click in the Modeler background area to deselect the substrate. Your model should look like the following figure:

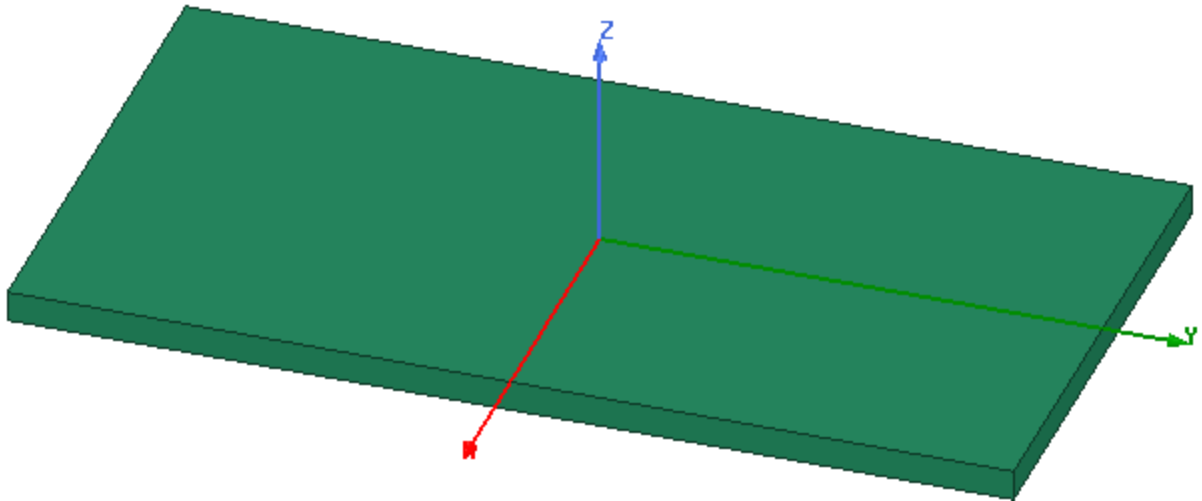

Create Copper Cladding

To create the ground plane, perform the following steps.

1. Click anywhere in the Modeler window and press **F** to enter the *Face* selection model.
2. Click the top face of the substrate to select it.
3. From the **Draw** ribbon tab, click **Surface > Create Object from Face**.
4. In the docked *Properties* window, change the object **Name** to **CuClad**, the **Color** to **orange**, and **Transparent** to **0**, as shown below:

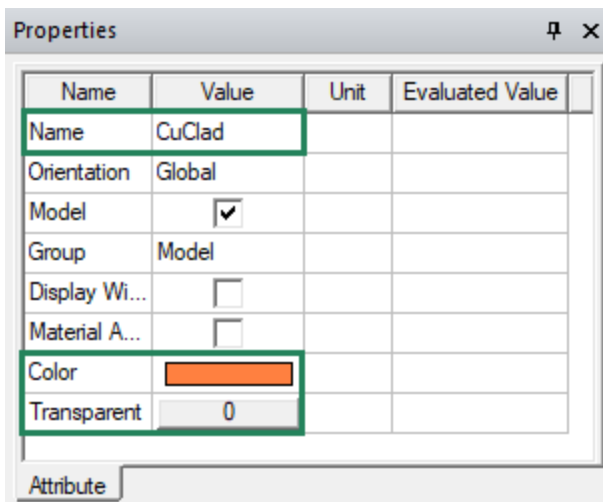

5. Click in the Modeler window's background area to deselect the CuClad object.

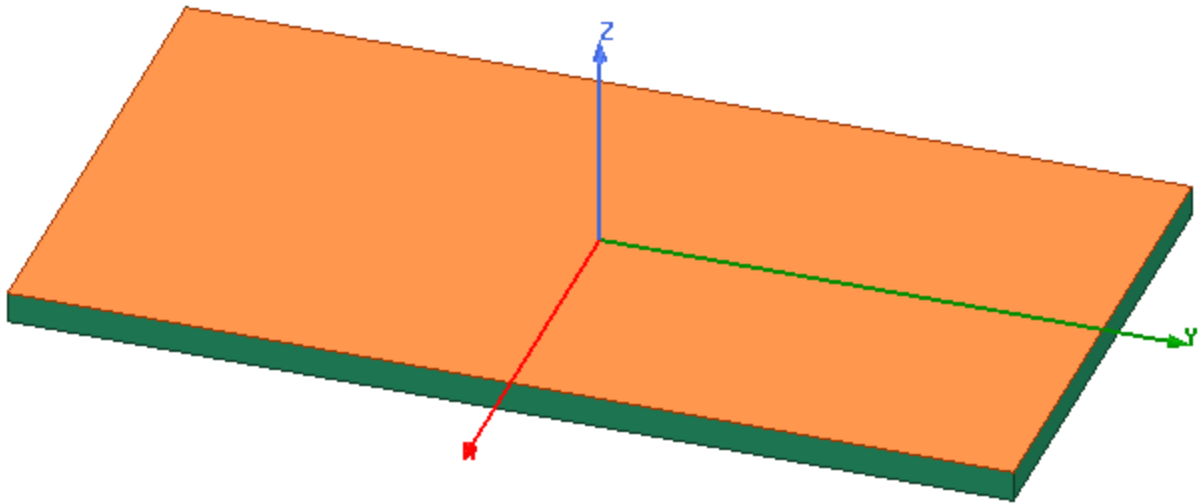

Assign Finite Conductivity to Copper Cladding

Perform the following steps to create the ground.

1. Press the F key to enter face selection mode.
2. Right-click **CuClad** in the History Tree and select **Assign Boundary > Finite Conductivity**.
3. Enter **CuBoundary** in the **Name** field.
4. Select **Use Material** and click the *material selector button* next to it. The *Select Definition* dialog box appears.
5. Enter **copper** in the **Search** field and click **OK** to use **copper** as the material.
6. Leave the **Infinite Ground Plane** option cleared.

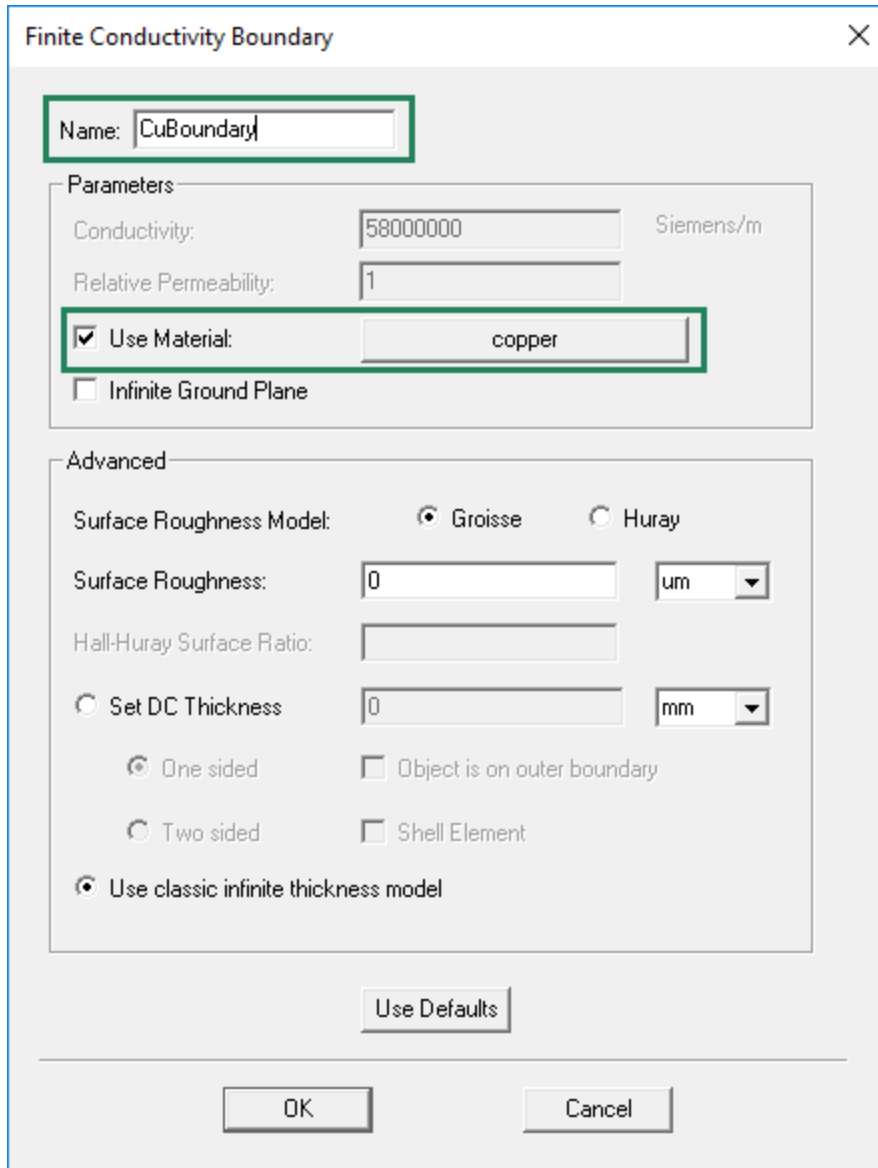

7. Click **OK**.
8. Select **CuBoundary** under *Boundaries* in the Project Manager to visualize the finite conductivity boundary you just assigned.

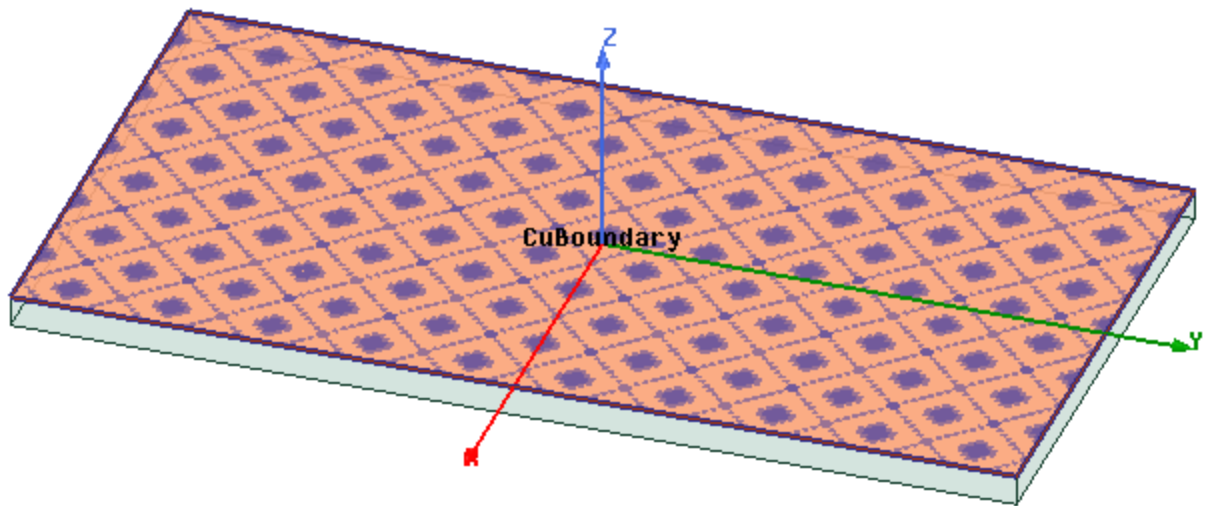

9. Click in the Modeler window's background area to clear the current selection.

Create Feed Cut Out

Perform the following steps to create the feed gap and the port area at the outside end of the feed.

1. From the **Draw** ribbon tab, click  **Rectangle**.
2. Click anywhere on the top surface of the substrate, move the mouse, and click again to create a rectangle.

The *Properties* dialog box appears as soon as you click the second time.

3. In the **Command** tab of the *Properties* dialog box, specify the following location and size values (all inputs in **mm**):
 - *Position*: **-0.5 mm, 0.5 mm, 0 mm**
 - *X Size*: **10.5 mm**
 - *Y Size*: **0.6 mm**

Command		Attribute		
Name	Value	Unit	Evaluated Value	
Command	CreateRectangle			
Coordinate Sys...	Global			
Position	-0.5 ,0.5 ,0	mm	-0.5mm , 0.5mm , 0mm	
Axis	Z			
XSize	10.5	mm	10.5mm	
YSize	0.6	mm	0.6mm	

- In the **Attribute** tab of the *Properties* dialog box, change the **Name** to **Feed_a**.
- Click **OK** to close the dialog box.

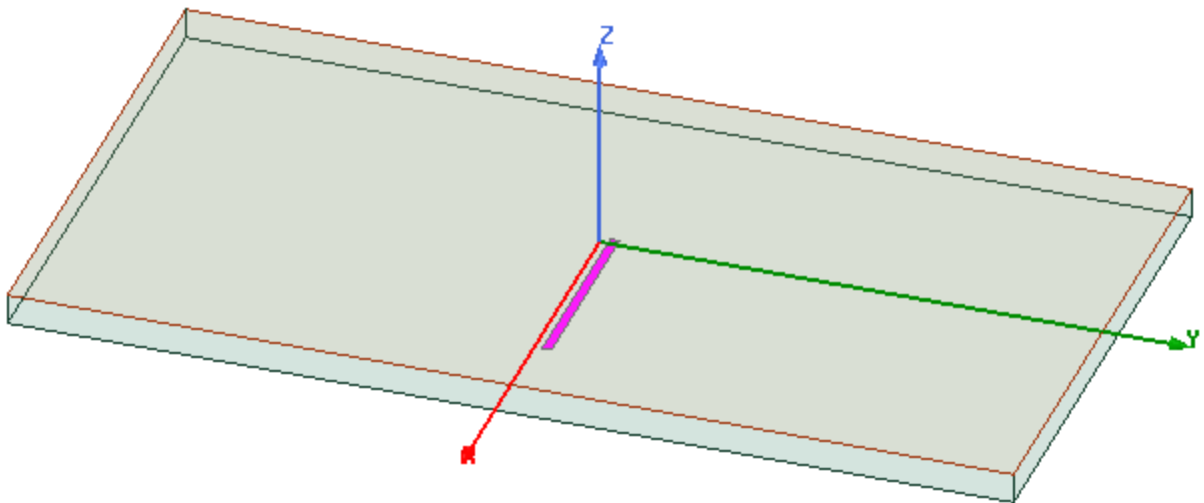

- Zoom in for a closer view of the outside end of the feed cutout rectangle you just drew.
- From the **Draw** ribbon tab, click  **Rectangle**.
- Click the bottom left corner of the feed cutout rectangle (+X, -Y corner), move the mouse up and to the left and click again to complete an initial rectangle.

The *Properties* dialog box appears as soon as you click the second time.

- In the **Command** tab of the *Properties* dialog box, specify the following location and size values (all inputs in **mm**):
 - *Position*: **10 mm, 0.5 mm, 0 mm**
 - *X Size*: **-0.6 mm**
 - *Y Size*: **-0.5 mm**

Command		Attribute		
Name	Value	Unit	Evaluated Value	
Command	CreateRectangle			
Coordinate Sys...	Global			
Position	10,0.5,0	mm	10mm, 0.5mm, 0mm	
Axis	Z			
XSize	-0.6	mm	-0.6mm	
YSize	-0.5	mm	-0.5mm	

10. In the **Attribute** tab of the *Properties* dialog box, change the **Name** to **Feed_b**.
11. Click **OK**.

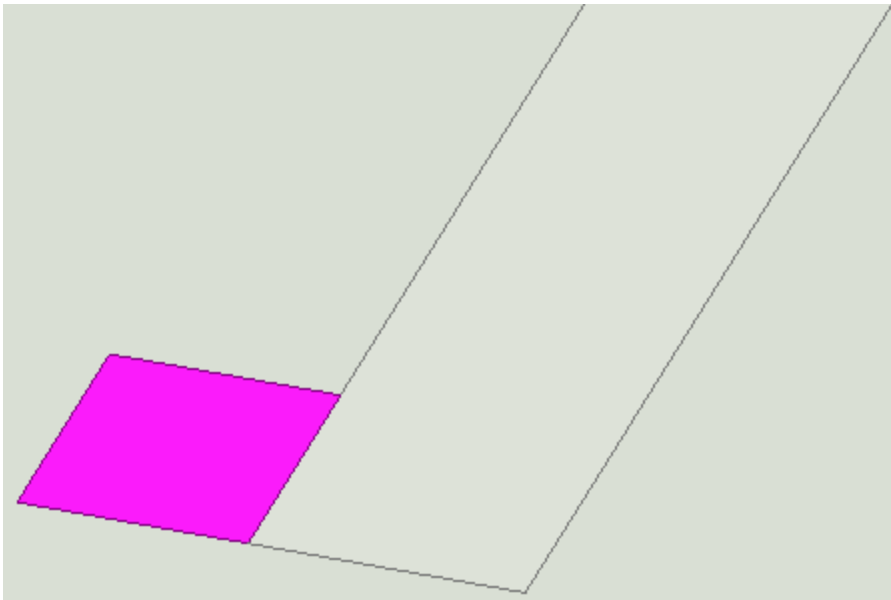

Create Bow Tie Arm

For this procedure, you will use the coordinate text boxes at the bottom of the Ansys Electronics Desktop window to input the line vertex positions. When typing values in the text boxes, be careful not to move your mouse, which would cause the coordinates to revert to the cursor location in the Modeler window.

1. Press **Ctrl + D** to fit the model to the viewing area.
2. Click in the Modeler window's background area to clear the current selection.
3. From the **Draw** ribbon tab, click  **Draw Line**.

Press **Tab** to jump into the **X:** text box. Thereafter, press **Tab** to jump to the next coordinate text box or from the last one (**Z:**) back to the first one (**X:**).

Enter the coordinates for the first vertex position, as follows.

- X: **-0.3**
 - Y: **0.5**
 - Z: **0**
 - Press **Enter**.
4. For the second vertex position, specify X: **-8.423**, Y: **25.5**, Z: **0**. Then, press **Enter**.
 5. For the third vertex position, specify X: **8.423**, Y: **25.5**, Z: **0**. Then, press **Enter**.
 6. For the fourth vertex position, specify X: **0.495**, Y: **1.1**, Z: **0**. Then, press **Enter**.
 7. Right-click in the Modeler window and select **Close Polyline**.

The fifth and final vertex is generated automatically at the same location as the first vertex and the *Properties* dialog box appears.

8. In the **Attributes** tab of the *Properties* dialog box, change the **Name** to **BowTie** and click **OK**.

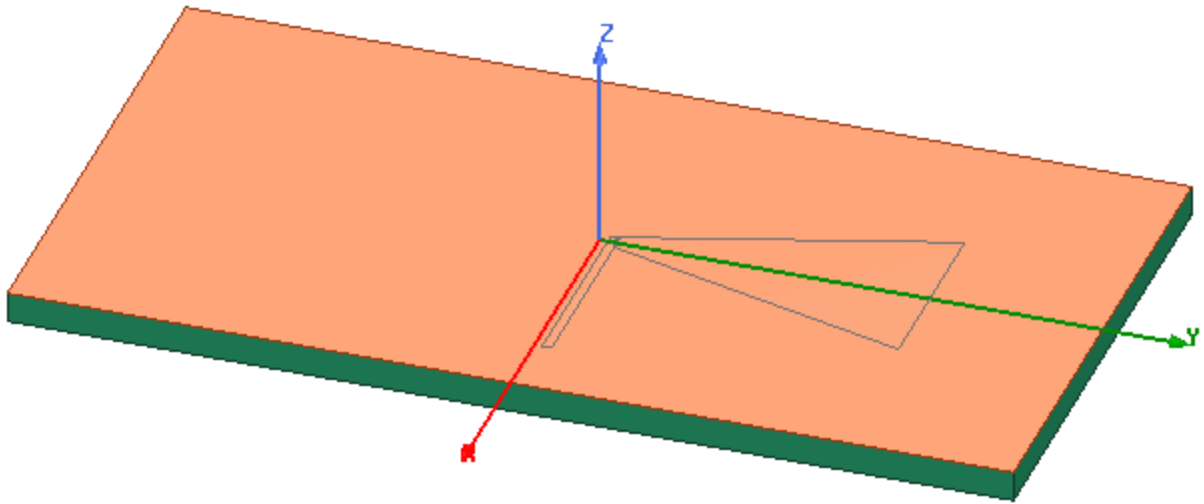

9. Zoom in for a better view of the intersection of the *BowTie* and *Feed* objects, so that you can see how they currently overlap each other.

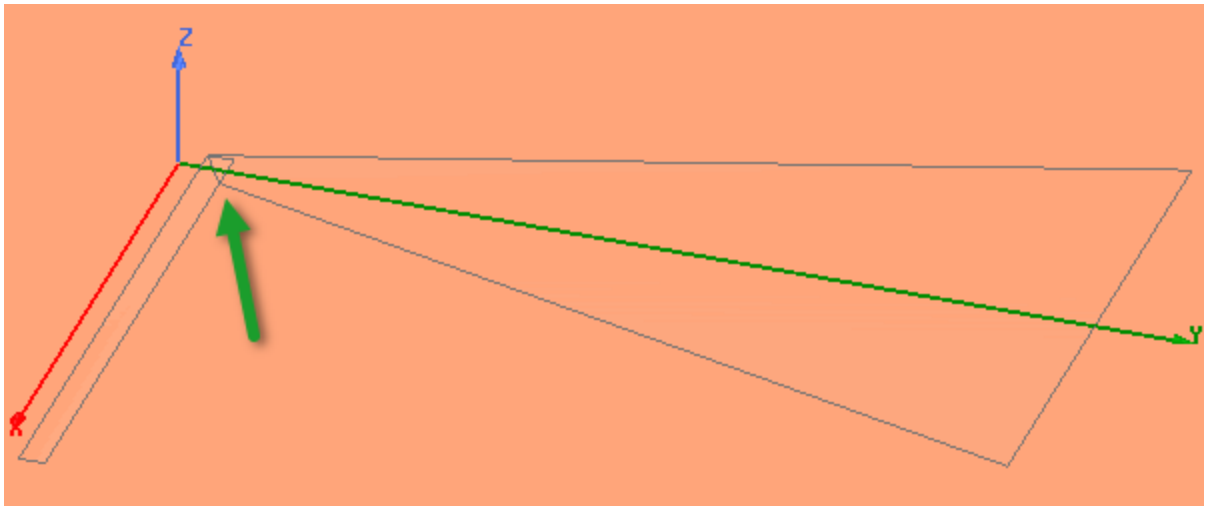



The overlap will be eliminated when the individual sheet objects are united in a later procedure.

Mirror the Feed and Bow Tie Objects

To create the duplicate that is the other side of the bow tie antenna, perform the following steps.

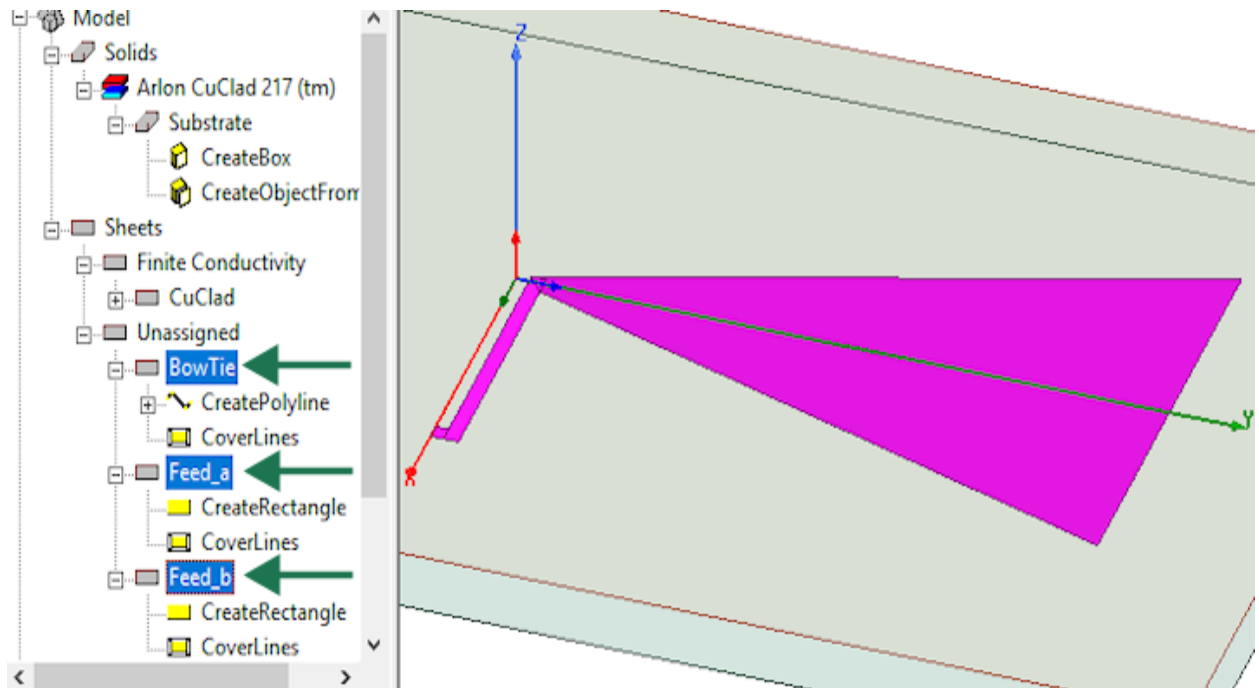
1. Under *Unassigned* in the History Tree, select **BowTie**, **Feed_a**, and **Feed_b**.



2. On the **Draw** ribbon tab, click  **Thru Mirror**.
3. Specify the starting vertex of the mirror normal vector using the coordinate text boxes:
 - Specify $X: 0$, $Y: 0$, $Z: 0$. Then, press **Enter**.
4. Specify the ending vertex of the mirror normal vector using the coordinate text boxes:
 - Specify $dX: 0$, $dY: 1$, $dZ: 0$. Then, press **Enter**.
5. Click **OK** to close the *Properties* dialog box that appears.
6. Press **Ctrl + D** to fit the model view.
7. Click in the Modeler window's background area to clear the current selection.

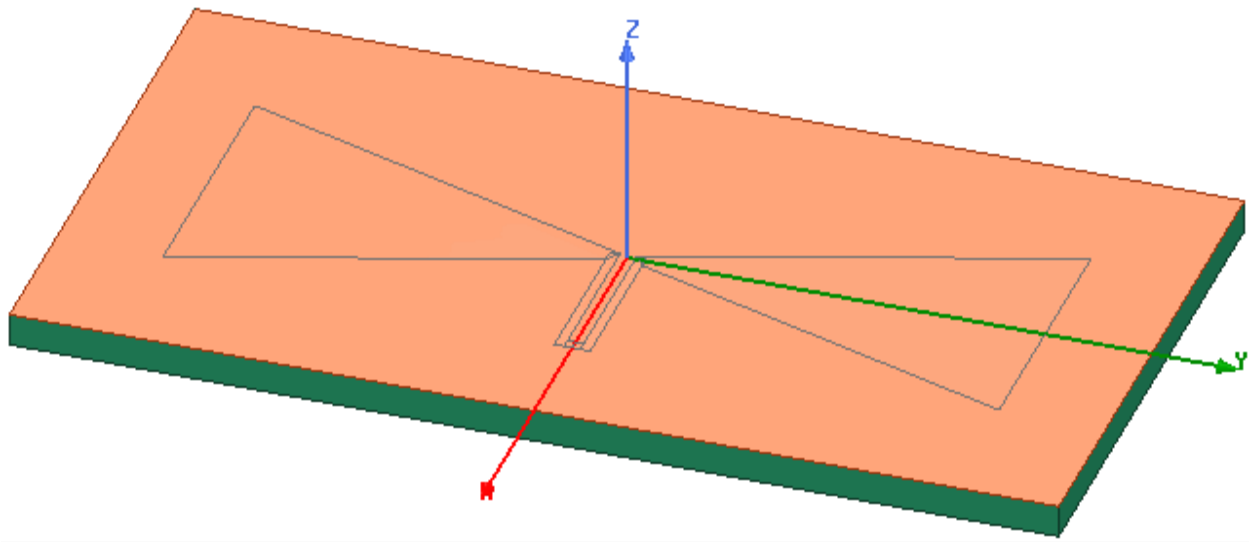

Unite Feed and Bow Tie Objects

To complete the bow tie arm, you need to unite the BowTie and the Feed objects. Do this as follows:

1. Select **BowTie** under *Unassigned* in the History Tree.
2. Press **Ctrl** and also select **BowTie_1**, **Feed_a**, **Feed_a_1**, **Feed_b**, and **Feed_b_1** in the History Tree.

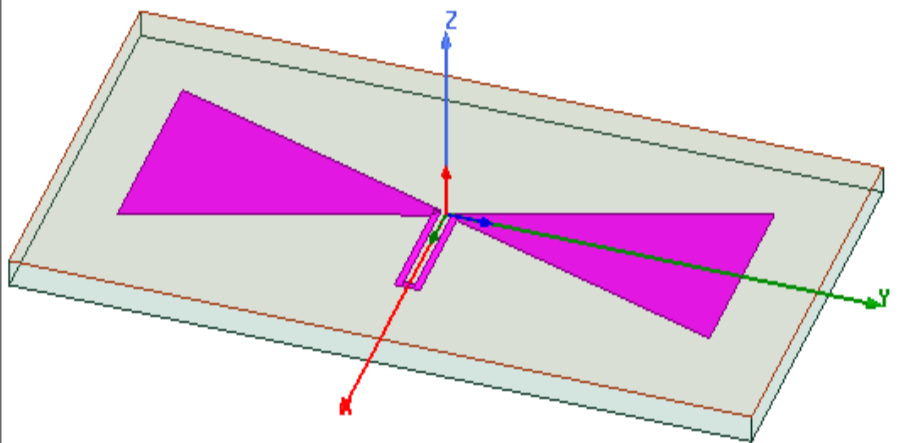
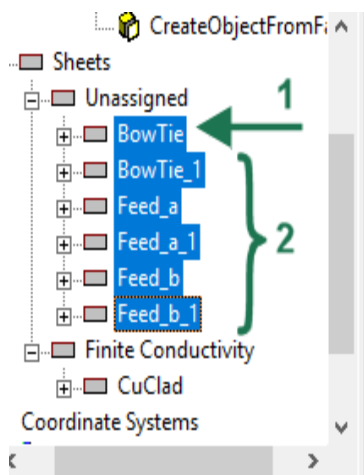

3. From the **Draw** ribbon tab, select the  **Unite**.

Note:

Alternatively, you can right-click and select **Edit > Boolean > Unite** from the shortcut menu.

All objects are combined into the single object, *BowTie*. The first object selected determines the name of the united object.

4. Click in the Modeler window's background to clear the current selection.

The bow tie antenna (sheet object) is complete. You will next subtract it from the copper cladding on top of the substrate. Finally, you will make it a hidden, non-model part so that the solver will ignore it. Only the bow tie shaped aperture in the ground plane is needed. The sole purpose of the BowTie object is to make the cutout in the copper cladding.

Open the Bow Tie Aperture in the Copper Cladding

To create the aperture in the copper cladding, subtract the bowtie from the cladding.

1. In the History Tree, select the objects **CuClad** and **BowTie** (*in that specific order*).
2. From the **Draw** ribbon tab, click  **Subtract**.
3. In the *Subtract* dialog box, ensure that **CuClad** is listed under *Blank Parts* and **BowTie** under *Tool Parts*. The order of selection determines which object is the blank part and which is the tool part.

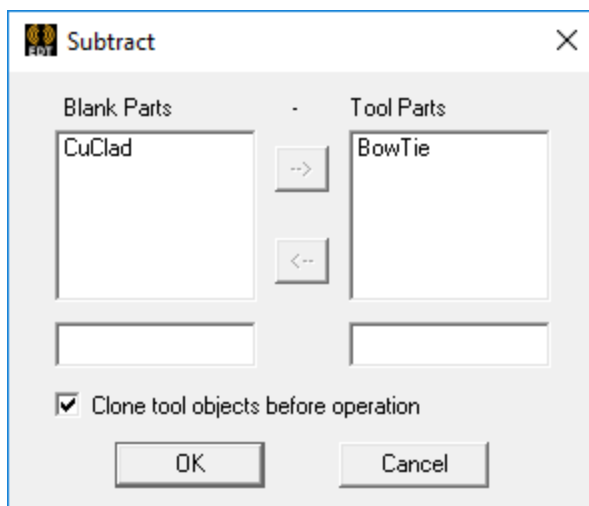

4. Select the **Clone tool objects before operation** option and click **OK** to perform the subtraction.
5. Click in the Modeler window's background area to clear the current selection.

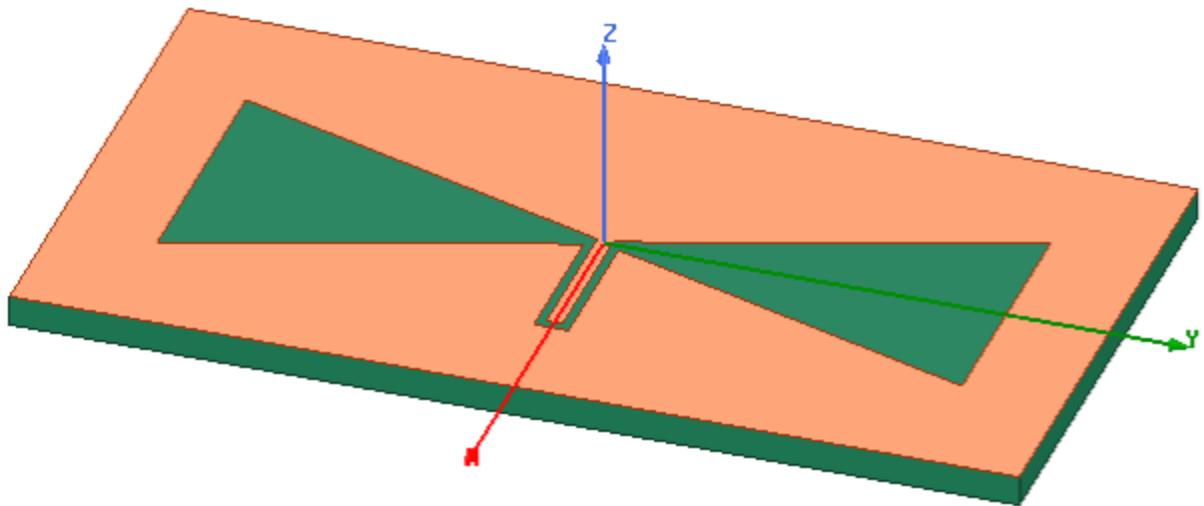

6. Under *Sheets > Unassigned* in the History Tree, select **BowTie**. Then, clear the **Model** option in the docked **Properties** window.

This action makes BowTie a Non-Model part. The solver will ignore it.

7. Under *Sheets > Non-Model* in the History Tree, right-click **BowTie** and choose **View > Hide in All Views** from the shortcut menu.

Excite the Antenna with a Lumped Port

To excite the bow-tie antenna you will assign a lumped port using the following procedure.

1. Zoom in to the port area of the *CuClad* object as shown below:

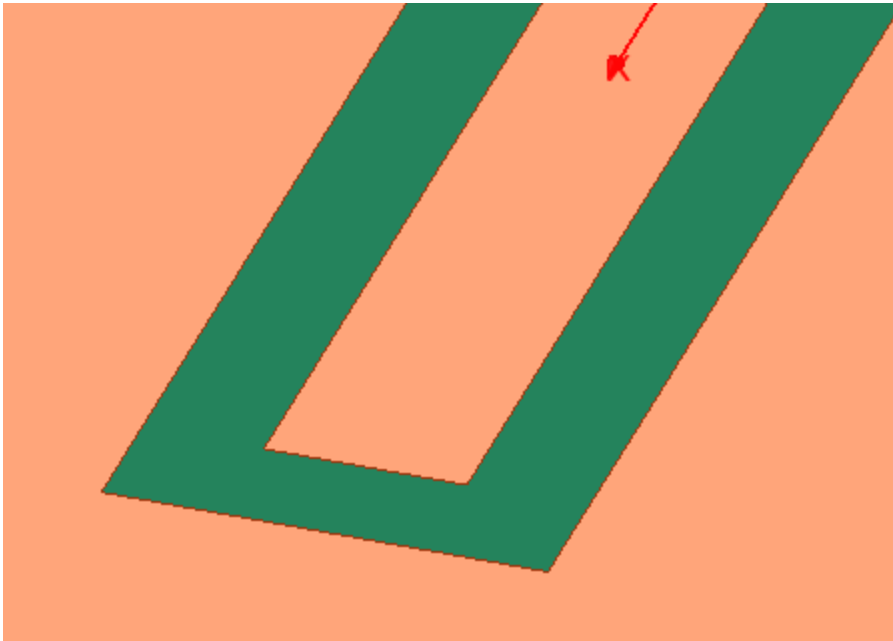

2. Press **E** to switch to the edge selection mode.
3. Click one of the two edges shown below then, holding **Ctrl**, click the other edge to also select it.

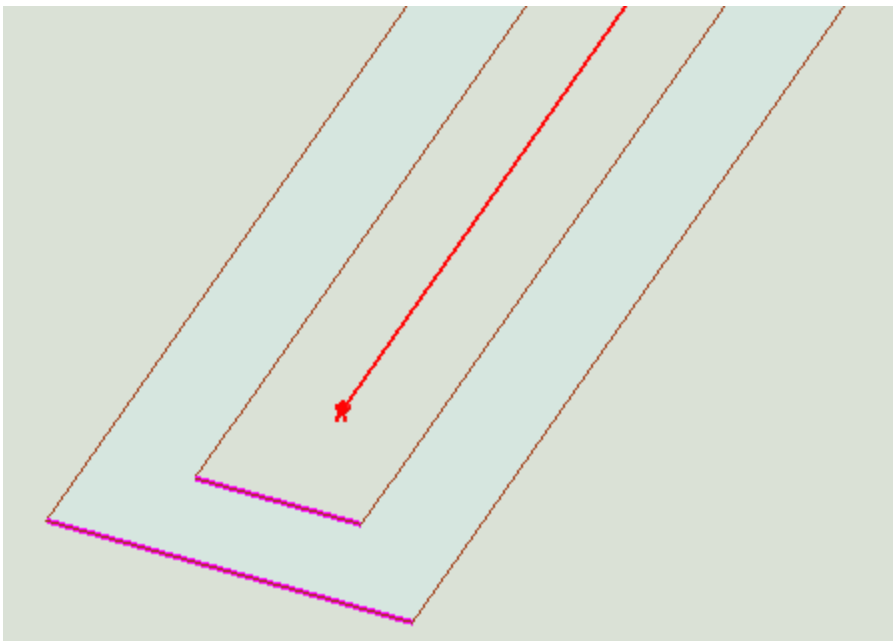

4. On the **Draw** ribbon tab, click  **Edge > Create Object From Edge**.
5. On the **Draw** ribbon tab, click  **Surface > Connect**.

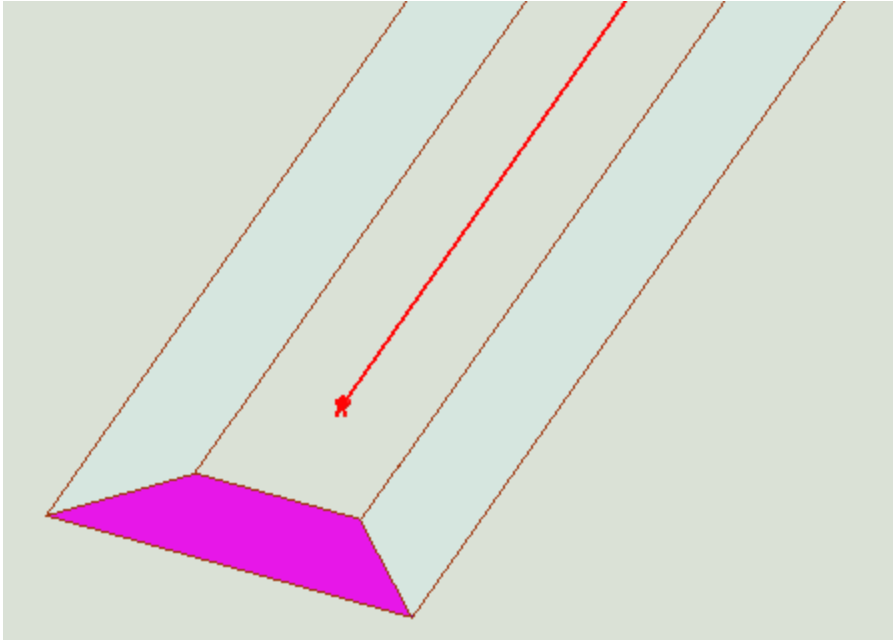

6. With the surface connecting the two edges still selected, right-click in the Modeler window and select **Assign Excitation > Port > Lumped Port**.

The *Lumped Port* dialog box appears.

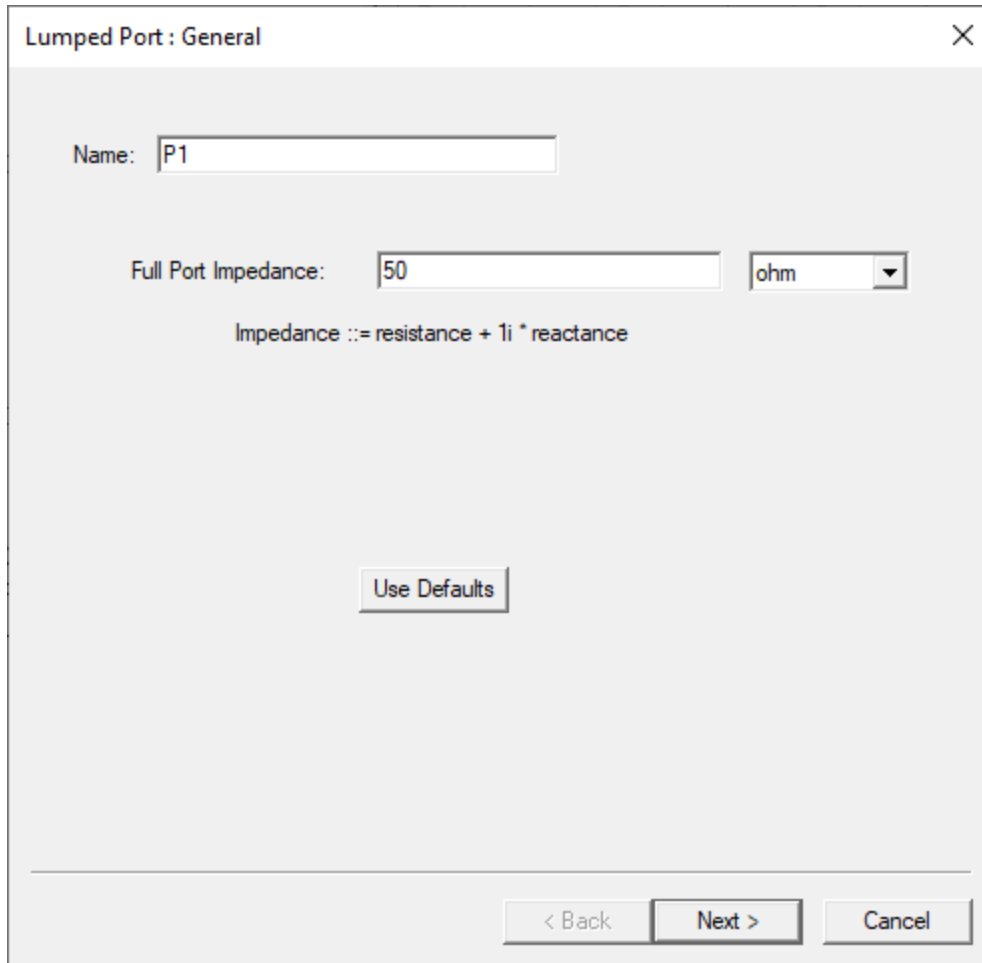

7. Change the **Name** to **P1**, keep the remaining options in the first panel at their defaults settings, and click **Next**.
8. From the drop-down menu in the first row of the **Integration Line** column, choose **New Line**. Then, draw an integration line from the midpoint of the longest edge of the selected face to the midpoint of the shortest edge of the same face, as shown in the following figure.

Note:

The cursor will snap to the midpoint of an edge when the cursor changes to a triangle.

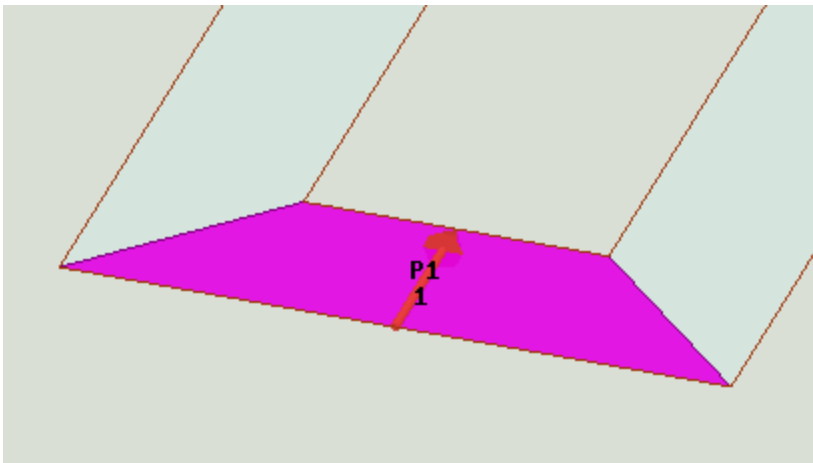
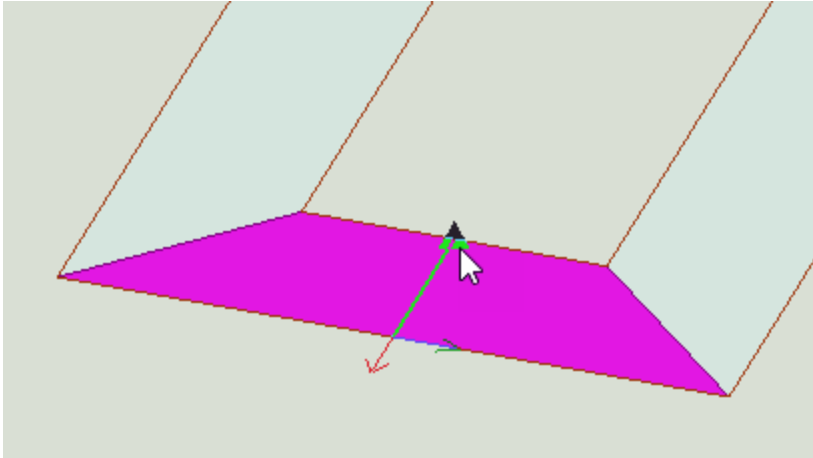

9. Click **Next** and then **Finish** to complete the lumped port assignment.
10. If the visualization of the lumped port excitation is not already displayed, select **P1** under *Excitations* in the Project Manager.

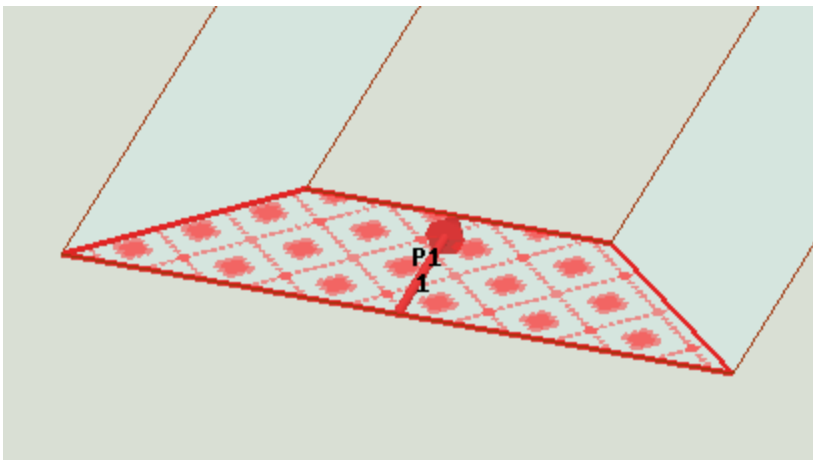

- Press **Ctrl + D** to fit the model to the viewing area and click in the background to clear the current selection.

Create Analysis Setup and Frequency Sweep

Add an Analysis Setup:

To create an analysis setup, perform the following steps. So that the results will be directly comparable to the parametric version of the bow tie antenna, we will use the same settings.

- In the Project Manager, double-click **Auto1** under **Analysis**.

The *Driven Solution Setup* dialog box appears.

- Under the *General* tab, change the **Setup Name** to **10GHz**.
- Enter **10GHz** as the **Solution Frequency**.
- Enter **8** for the **Maximum Number of Passes**.

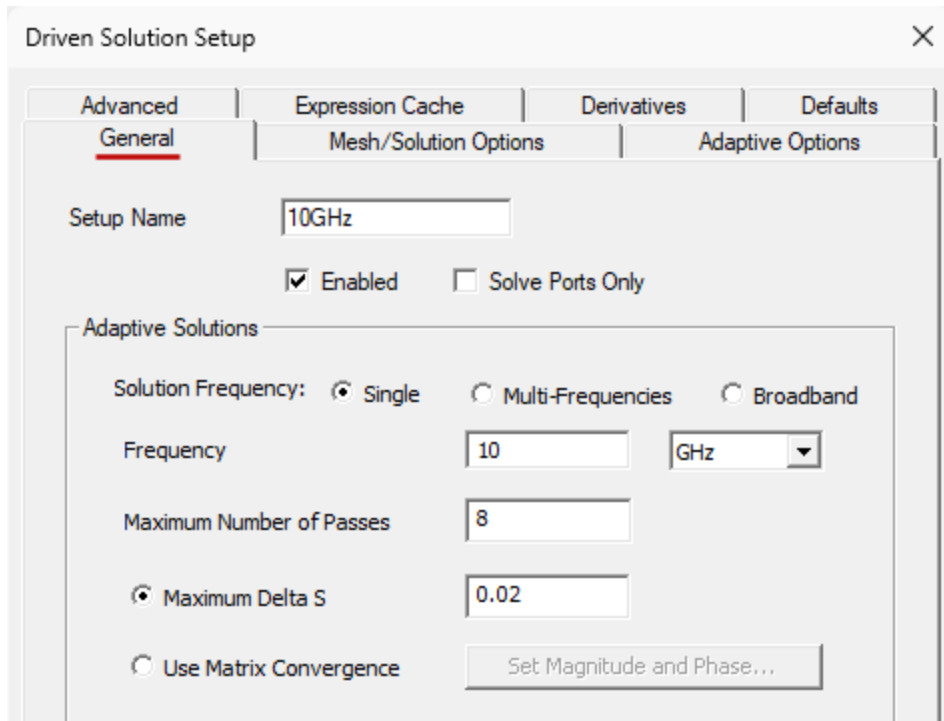

- Accept the default values for the remaining settings and click **OK**.

Add a Frequency Sweep:

- Select **10GHz** under *Analysis* in the Program Manager.
- On the **Simulation** ribbon tab, click  **Sweep**.

The *Edit Frequency Sweep* dialog box appears.

8. Under the *General* tab, change the **Sweep Name** to **8_12GHz**.
9. Choose **Interpolating** from the **Sweep Type** drop-down menu.
10. Choose **Linear Step** as the **Distribution** type under *Frequency Sweeps*.
11. Enter **8GHz** as the **Start** frequency, **12GHz** as the **Stop** frequency, and **0.01** as the **Step Size**.

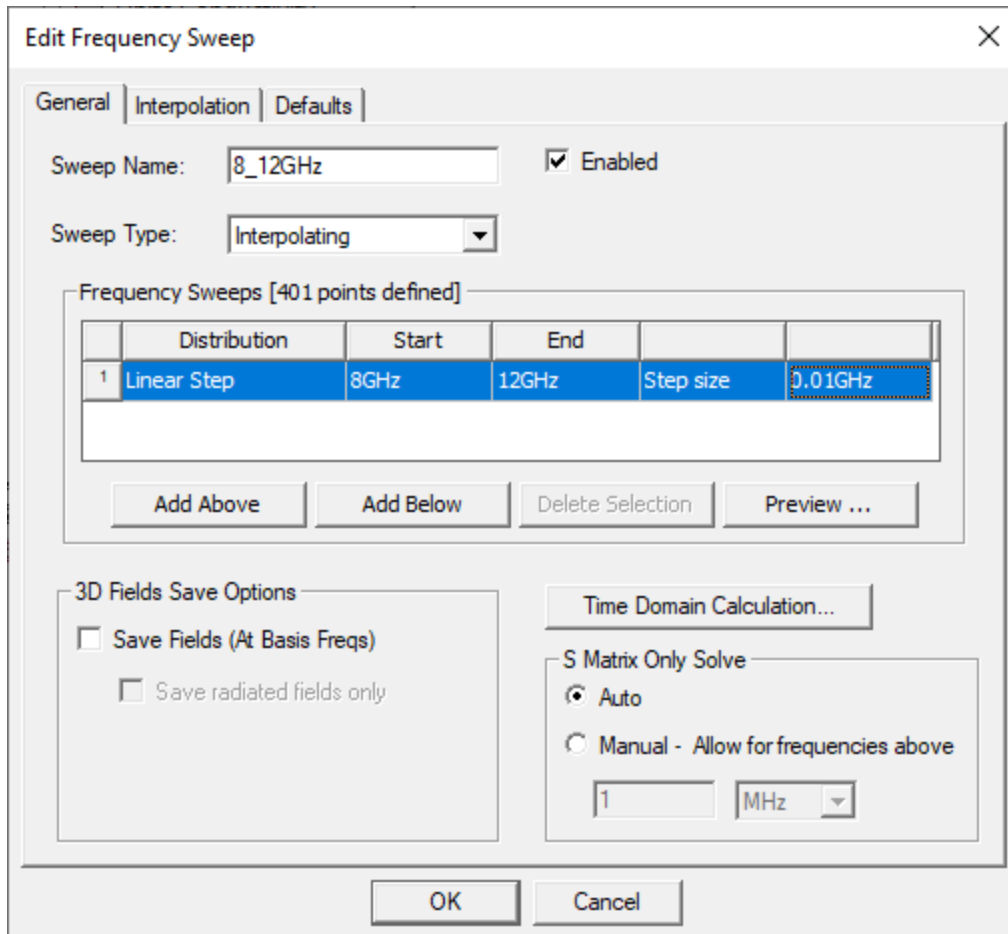

12. Click **OK**.

Create Radiation Setup

There is no need to use the *Create Open Region* command for radiation results, as you did for the *Parametric* version of the bow tie antenna. This time, you enabled the *Auto-Open Region* option when setting up the *Solution Type* settings.

You can double-click the predefined radiation setups created by the *Auto-Open Region* option and edit the Phi and Theta values, or you can create a new setup. In the *Parametric* tutorial, you used the first method. This time, create a new far field setup as follows:

1. In the Project Manager, right-click **Radiation** and choose **Insert Far Field Setup > Infinite Sphere**.
2. Enter **Principal Plane** in the **Name** field.
3. Define **Phi**: *Start = 0, Stop = 90, Step Size = 90*.
4. Define **Theta**: *Start = -180, Stop = 180, Step Size = 1*.

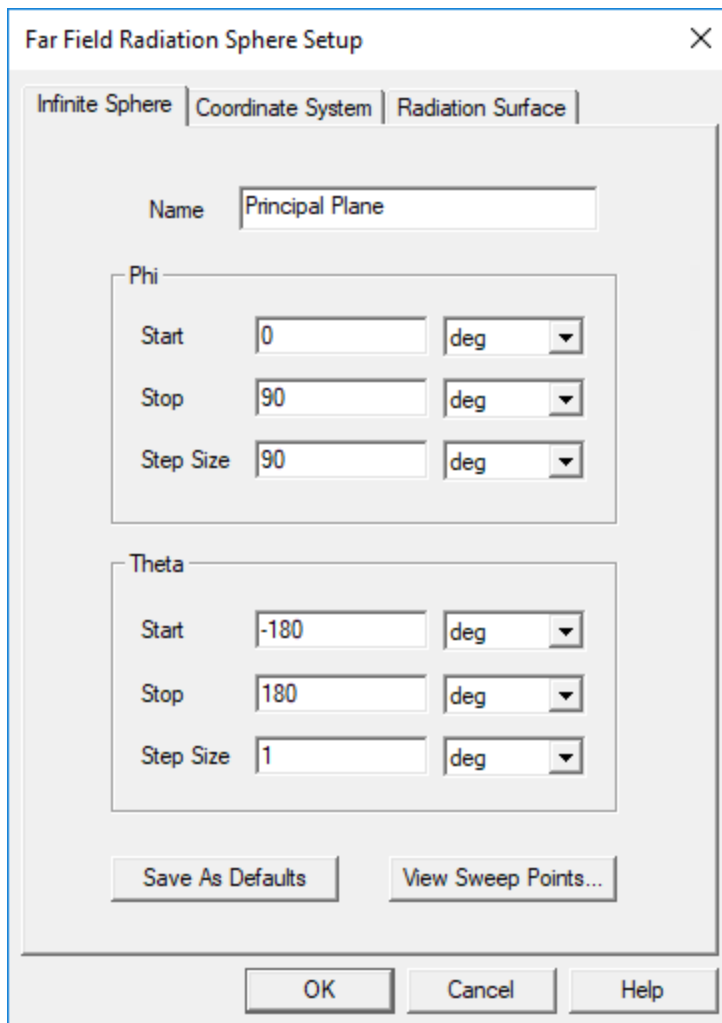



5. Click **OK**.

Note:

Though you used a different method to define the far field setup, the end result is identical to the *Principal Plane* far field setup you created during the *Parametric Bow Tie Antenna* procedure.

Validate and Analyze the Design

Before running the simulation, make sure the design passes the validation check as follows:

1. First  **Save** the design.
2. On the **Simulation** ribbon tab, click  **Validate**.

This command brings up the following dialog box:

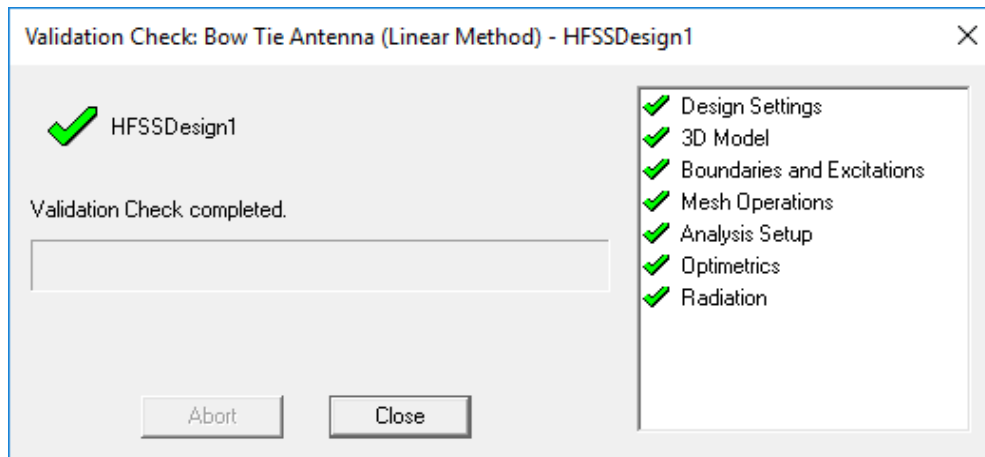

The validation check shows no problems, and you are ready to analyze the model.

3. Click **Close**.
4. On the **Simulation** ribbon tab, click  **Analyze All**.

Generate Reports

As soon as the analysis finishes, you can begin generating the reports. Perform the following steps.

Create an S Parameter Plot:

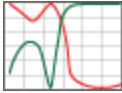
1. In the **Results** ribbon tab, click  **Modal Solution Data Report** >  **2D**.

The *Report* window appears.

2. Define the report as follows:
 - a. From the **Solution** drop-down menu, select **10GHz: 8_12GHz**.
 - b. Under **Category** select **S Parameter**.

- c. Under **Quantity** select **S(P1,P1)**.
 - d. Under **Function**, select **dB**.
3. Click **New Report** and then, click **Close**.

The S-parameter plot is generated.

4. To adjust the Y axis scale, double-click anywhere in the report to bring up the *Properties* dialog box.
5. Click the **Y1 Scaling** tab and select **Specify Min**, **Specify Max**, and **Specify Spacing**.
6. Change **Min** to **-26**, **Max** to **-4**, and **Spacing** to **2**.
7. Click **OK**.

Your plot should be similar to the following figure.

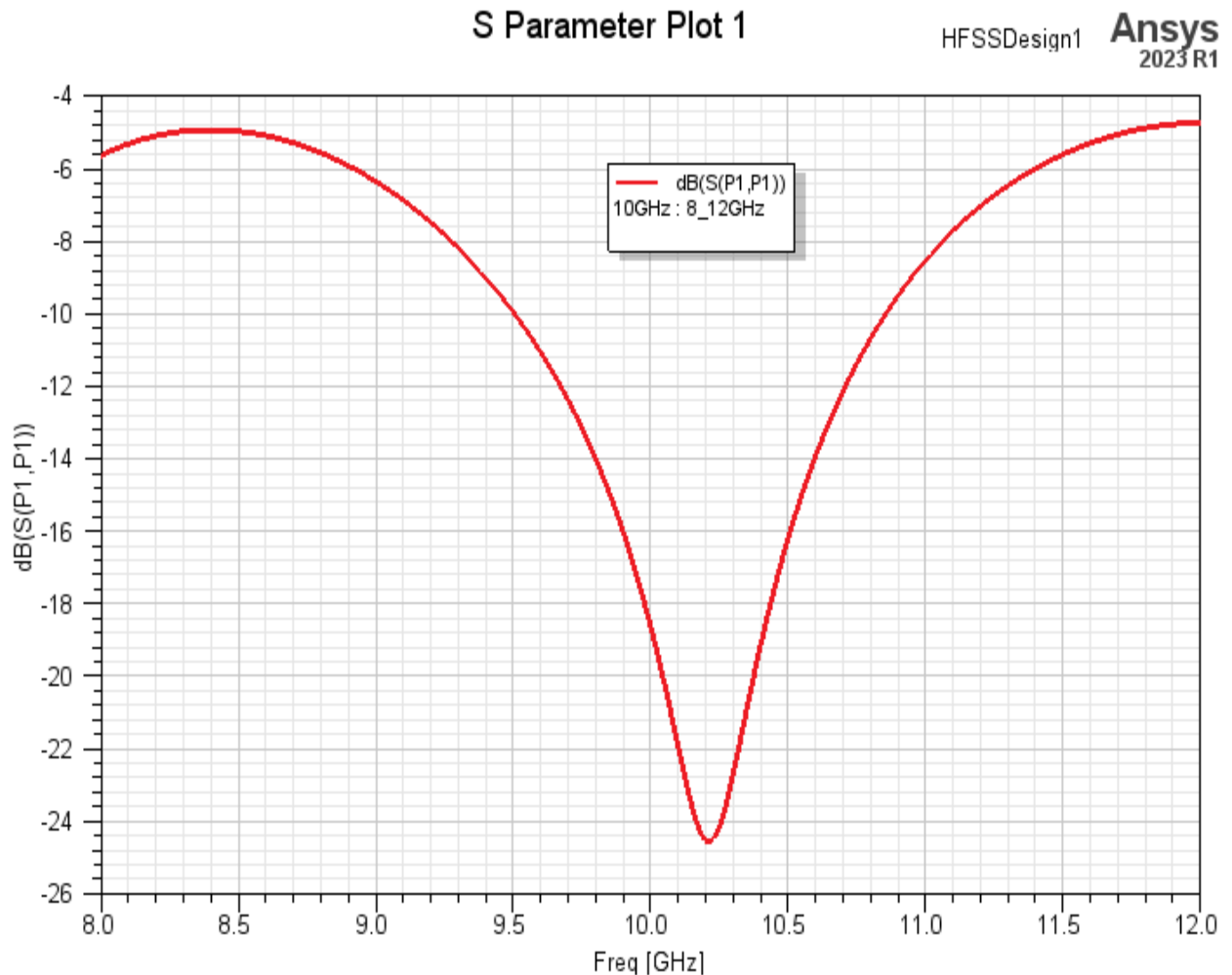

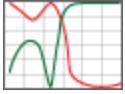

Create a Z Matrix Plot:

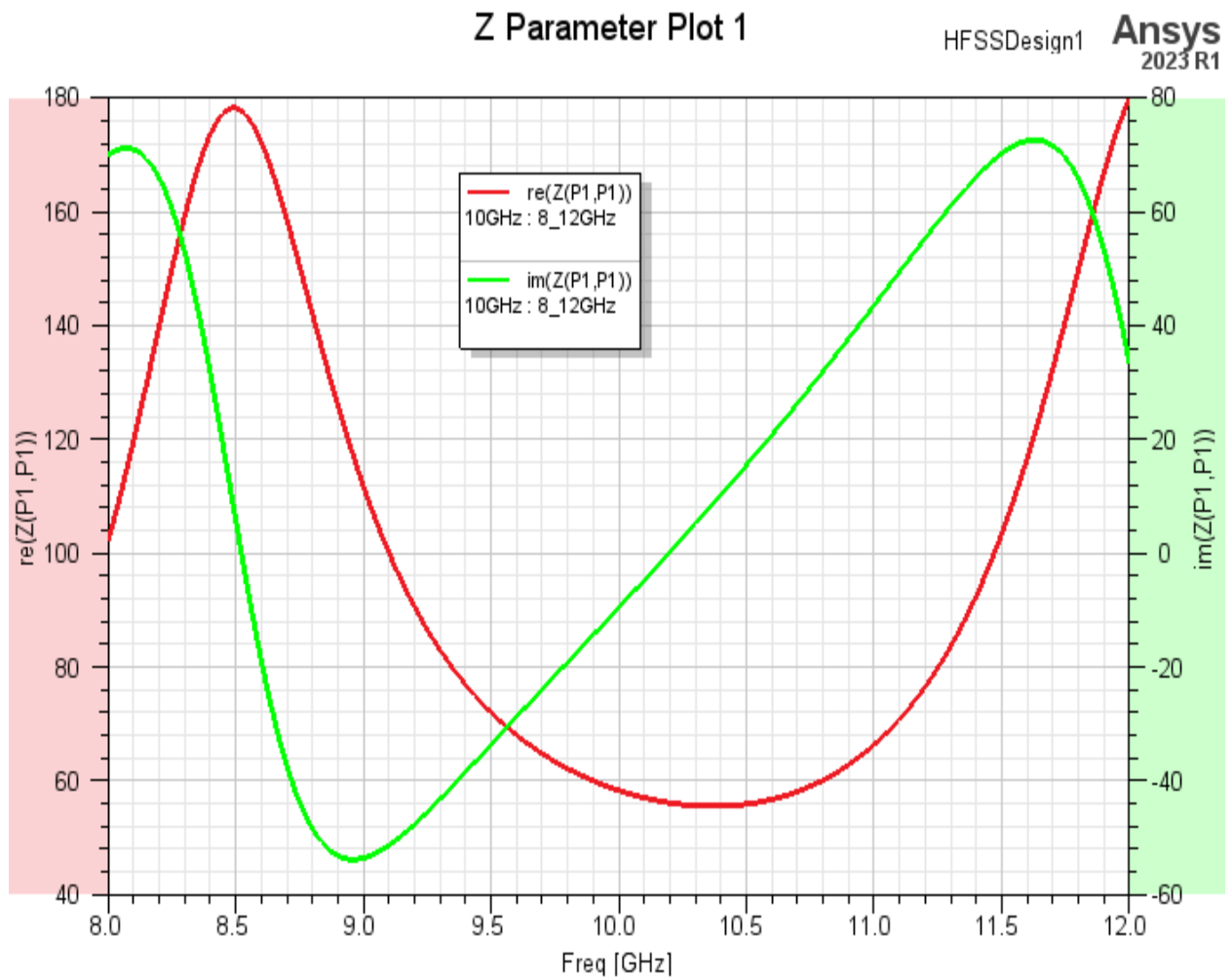
8. In the **Results** ribbon tab, click  **Modal Solution Data Report** >  **2D**.
9. Define the report as follows:
 - a. From the **Solution** drop-down menu, select **10GHz: 8_12GHz**.
 - b. Under **Category** select **Z Parameter**.
 - c. Under **Quantity** select **Z(P1,P1)**.
 - d. Under **Function**, select **im** and **re**. (Hold **Ctrl** to make multiple selections.)
10. Click **New Report** and click **Close**.
11. Select **im(Z,P1,P1)** from the Project Manager and change the **Y axis** to **Y2** in the docked *Properties* window.
12. Click in the plot window background area to deselect the *im* curve. You plot should resemble the following figure:



13. Optionally, double-click the plot and, from the *Properties* dialog box, change the limits and spacing under the *Y1 Scaling* and *Y2 Scaling* tabs.

Create a Radiation Pattern Plot:

14. From the **Results** ribbon tab, click  **Far Fields Report** >  **Mag/Ang Polar**.
15. Define the report as follows:
 - a. From the **Solution** drop-down menu, select **10GHz: LastAdaptive**.
 - b. From the **Geometry** drop-down menu, select **Principal Plane**.
 - c. Under **Category** select **rE**.
 - d. Under **Quantity** select **rETotal**.
 - e. Under **Function**, select **<none>**.
16. Under the **Families** tab, click the elipsis button (...) for the variable **Phi**. Then, do the following:
 - a. Click **Select Values**
 - b. Select **0deg**.
17. Click **New Report** but leave the dialog box open.

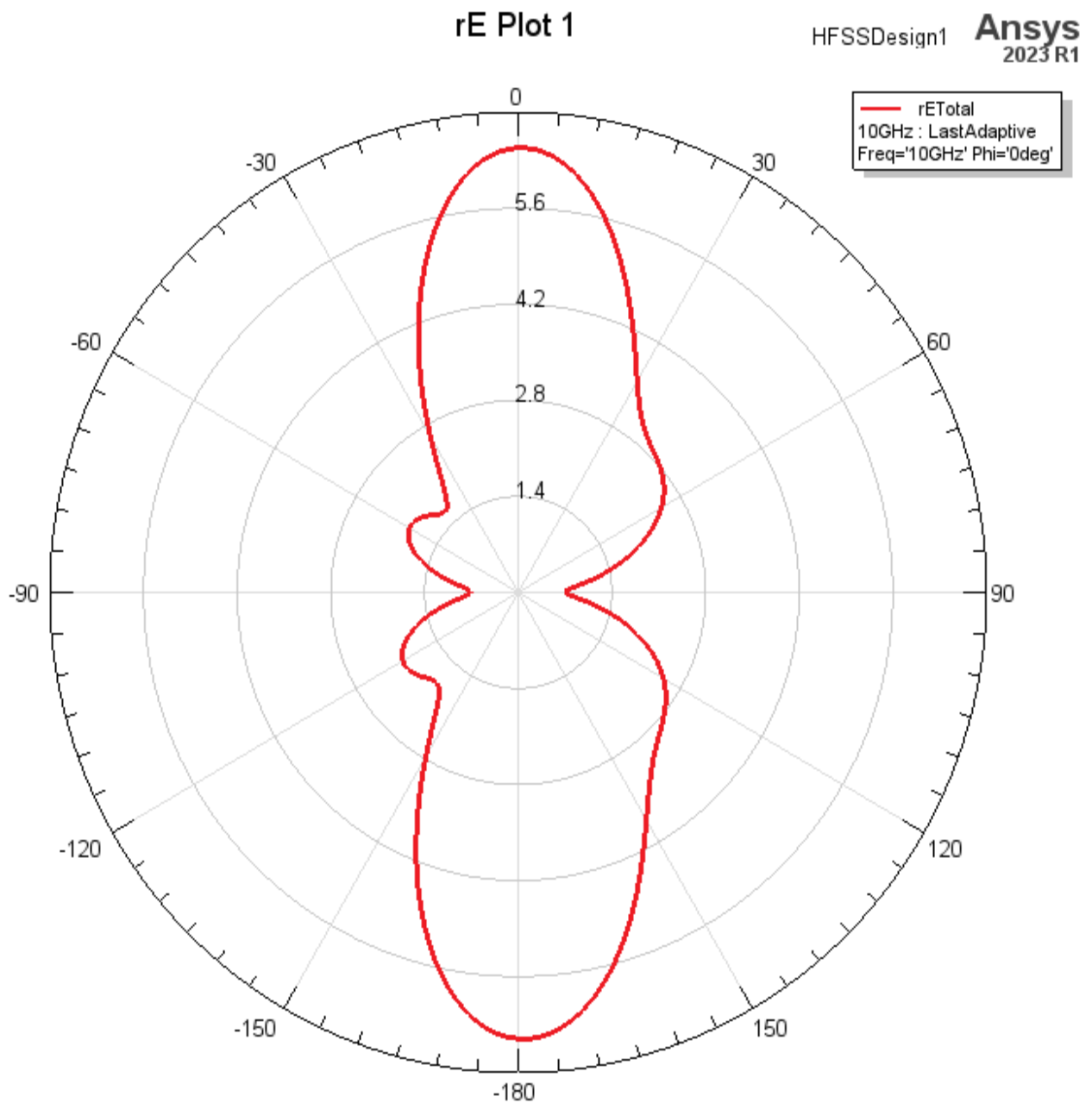

18. Repeat steps 16, but this time, choose **90deg** for **Phi**.
19. Click **New Report** and **Close**.
20. Click directly on the curve on *rE Plot 2*. Then, in the docked *Properties* window, change the **Color** to a **medium blue** shade.

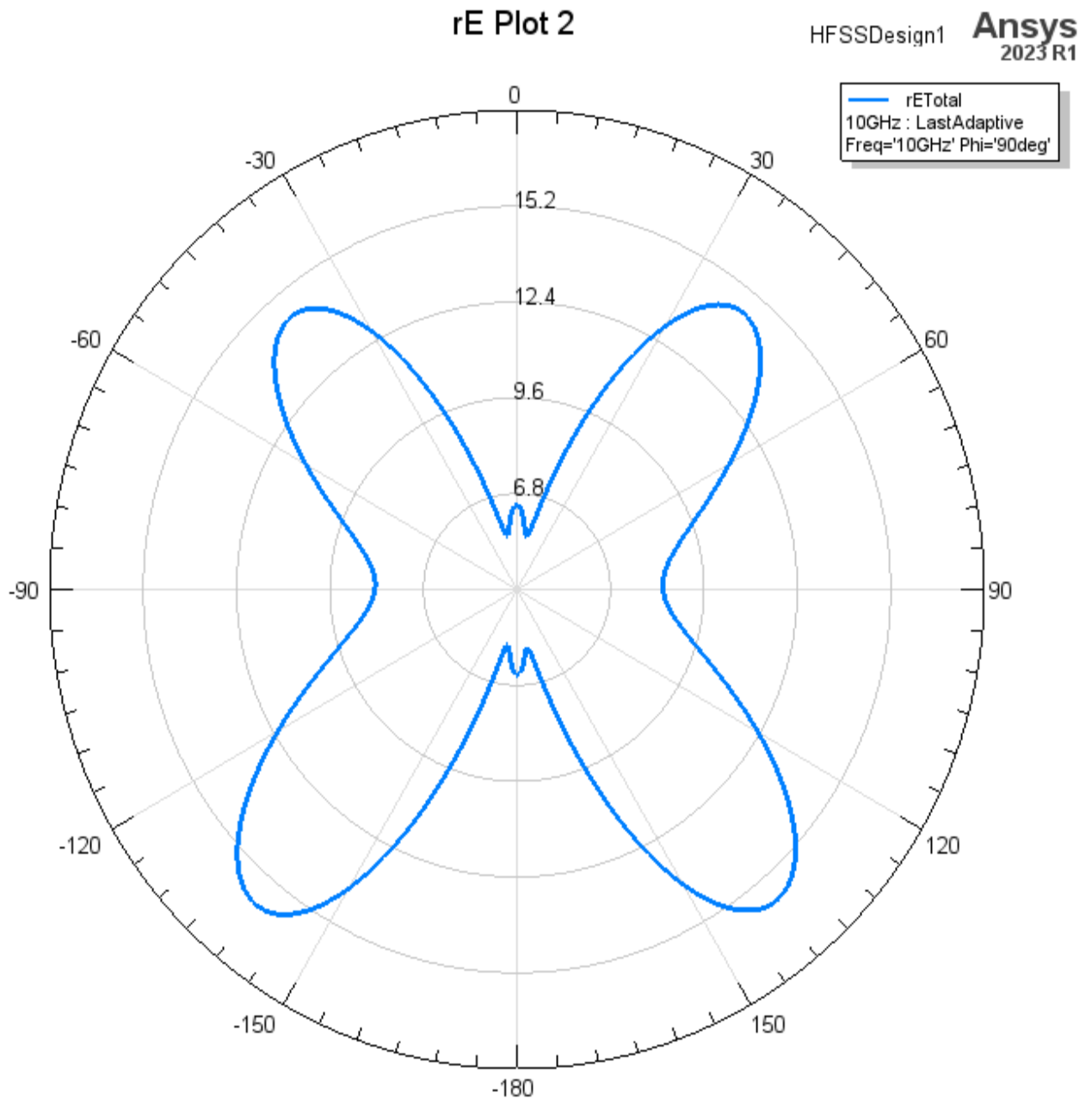

The results obtained for the bow tie antenna built using a conventional linear approach are very similar to the results for the parametric version. Very slight differences in geometry can cause changes in the meshing and convergence behavior. A close comparison of results will find them to be slightly different, but not significantly.

21. Optionally, you could create a gain plot and overlay the gain and radiation plots on the geometry, as you did in these earlier sections:

- [Create Far Field Pattern \(3D Polar Plot\)](#)
- [Overlay Radiation Pattern](#)

22.  **Save** your project.

You have completed the bow tie antenna exercise using the linear construction method. You can close the project now.

5 - Antenna Design Toolkit

The antenna design toolkit is a standalone utility that automates geometry creation, solution setup, and post processing reports for several popular antenna elements. You can quickly generate the antenna design types of your choice directly from the toolkit and simulate them at desired frequencies and review the results.

Note:

The **ACT Extensions** window and the design wizards it contains (*5G Wizard*, **HFSS Antenna Design Toolkit**, *HFSS-Savant Datalink*, and *Maxwell Eccentricities*) are only available for the Windows version of the Ansys Electronics Desktop software. These items are not available when the software is installed on a Unix/Linux platform.

ACT Extensions

You can launch an antenna design directly from the HFSS Antenna Design Toolkit, which is accessible from the ACT Extensions wizards. You can choose the type of antenna you want and specify antenna parameters such as dimensions for element and feed, the choice of boundary conditions, frequency etc. If you specify the operating frequency only, HFSS automatically synthesizes the antenna of your choosing without the need for you to enter the dimensions for element, feed etc. The synthesis feature automatically figures out the dimensions based on the specified frequency.

Note:

The **ACT Extensions** window and the design wizards it contains (*5G Wizard*, **HFSS Antenna Design Toolkit**, *HFSS-Savant Datalink*, and *Maxwell Eccentricities*) are only available for the Windows version of the Ansys Electronics Desktop software. These items are not available when the software is installed on a Unix/Linux platform.

Perform the following steps to generate a bow tie antenna from the toolkit:

1. Launch Ansys Electronics Desktop.
2. Typically, an new project is automatically created when you launch Electronics Desktop. You will not need this empty project, since the HFSS Antenna Toolkit will create a project of its own on completion. Therefore, right-click on the empty project at the top of the Project Manager and click **Close**.
3. From the menu bar, click **View > ACT Extensions**.

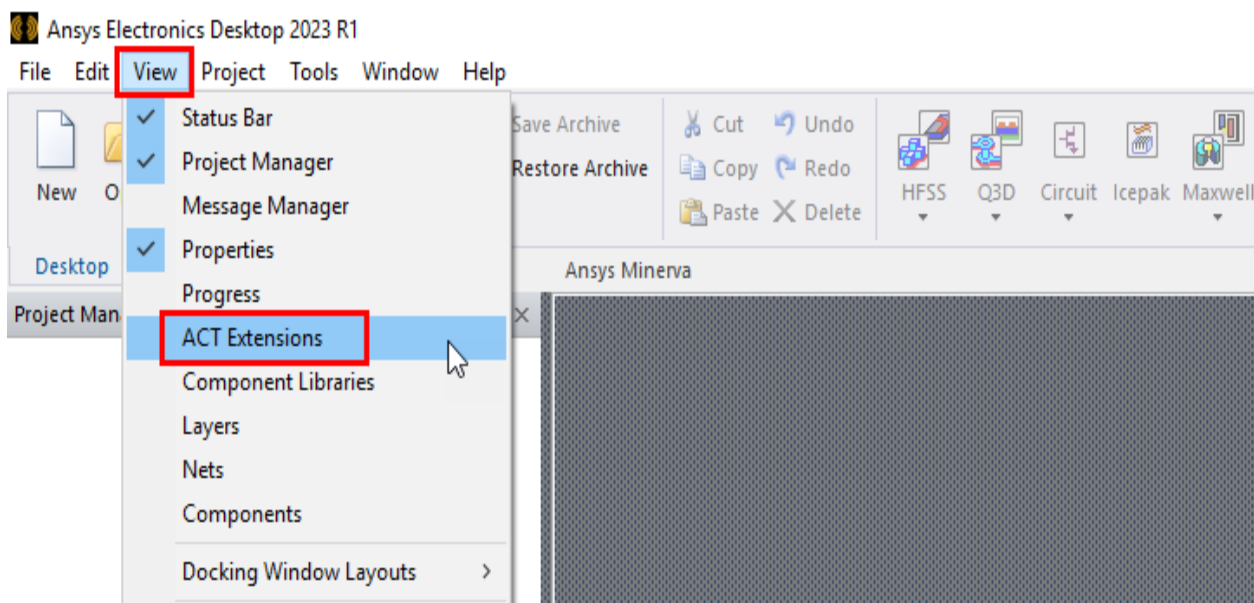

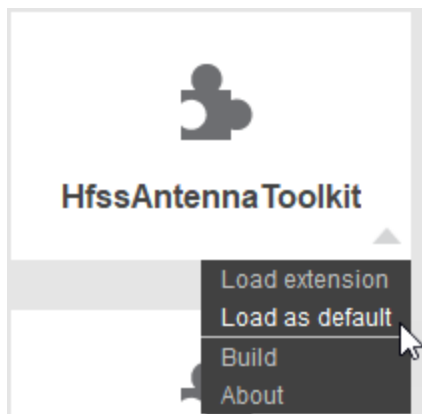

The *ACT Extensions* window opens.

4. In the top panel of the *ACT Home* window, scroll down as needed and click  **Manage Extensions**.
5. Optionally, if the **HfssAntennaToolkit** extension is not currently loaded (as indicated by a green icon background), do the following:
 - a. Click the down-arrow below and to the right of this extension.
 - b. Click **Load as default**.

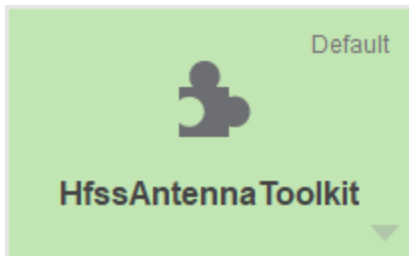

The extension background will now be green, and this extension will be loaded automatically for future program sessions:



- c. Click the  **left arrow** in the upper left corner of the *ACT Extensions* window to return to the start page.

6. Click  **Launch Wizards**.

A list of the available design *Wizards* appears in the *ACT Extensions* window.

7. Click  **HFSS Antenna Toolkit**.

The *HFSS Antenna Toolkit* appears in the *ACT Extensions* window.

8. Click and drag the left edge of the *ACT Extensions* window to resize it. Make the window wide enough to comfortably fit and view all the contents of the *HFSS Antenna Toolkit*.
9. Under *Bowtie* in the *Category* list, select **Bowtie Antenna**.

The screenshot displays the 'HFSS Antenna Toolkit' window within the 'ACT Extensions' environment. The interface is divided into several sections:

- Antenna Type:** A list of antenna types is shown on the left, with 'Bowtie Antenna' selected and highlighted by a mouse cursor. Other options include Bowtie Antenna - Rounded, Bowtie Antenna - Slot, Conical Spiral, Custom, Dipole, Helix, Horn, Log Periodic, Misc, Monopole, PIFA, Patch Antenna, PlanarSpiral, Reflector, Slot Antenna, Vivaldi Antenna, Waveguide, Yagi-Uda, and PersonalLib.
- Synthesis:** A button labeled 'Synthesis' is located at the top right of the configuration area.
- Settings - Bowtie Antenna:** This section contains the following parameters:
 - Center Frequency [GHz]: 1.0
 - Outer Boundary: Radiation
 - Huygens Box
- Antenna Dimensions:** This section contains the following parameters:
 - Inner Width [cm]: 0.22
 - Outer Width [cm]: 4.01
 - Arm Length [cm]: 4.46
 - Port Gap Width [cm]: 0.22
- Substrate Dimensions:** This section contains the following parameters:
 - Material: Duroid (tm)
 - Substrate Height [cm]: 0.1575
- Help:** A section titled 'Help' provides additional information:
 - Name:** Bowtie Antenna
 - Diagram:** A 3D perspective view of the bowtie antenna on a substrate. Labels indicate 'Substrate Dimension X', 'Substrate Dimension Y', 'Inner Width', 'Port Gap Width', 'Arm Length', 'Outer Width', and 'Substrate Thickness'.
 - Author:** Arien Sligar

At the bottom of the window, there are three buttons: 'Exit Wizard', 'Back', and 'Finish'.

The bowtie antenna settings appear on the right side of the wizard, including *Antenna Settings*, *Antenna Dimensions*, and *Substrate Dimensions*.

10. Enter **10** in the **Center Frequency [GHz]** text box.
11. Under *Substrate Dimensions*, select **Edit** from the **Material** drop-down menu.

The *Material Properties* dialog box appears.

12. Select **Arlon Cu Clad 217 (tm)** from the material list and click **OK**.

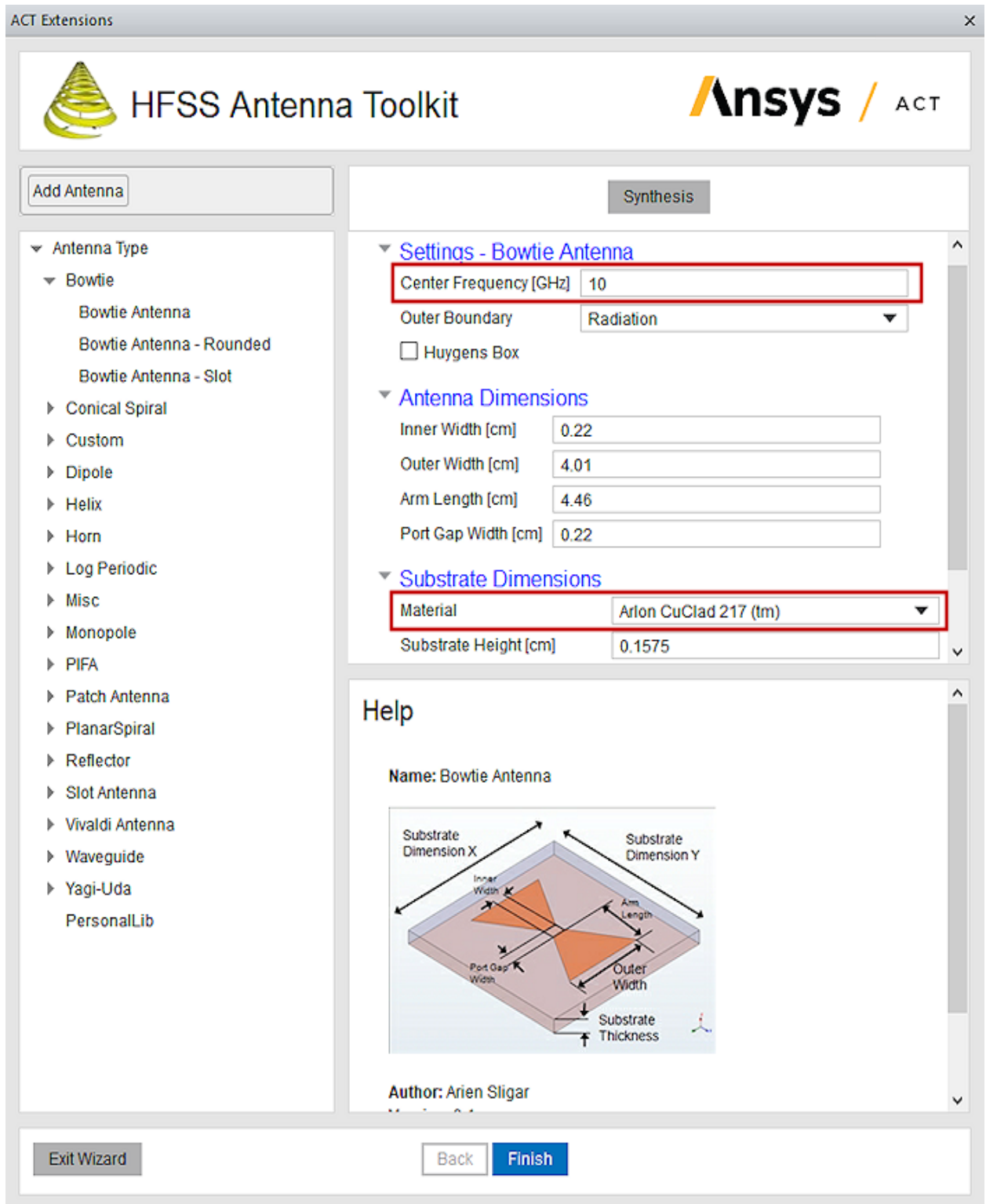

13. Select the **Huygens Box** option.

14. Click the **Synthesis** button to update the antenna and substrate dimensions automatically.



15. Click **Finish** and close the *ACT Extensions* window.

The toolkit generates the bow tie antenna and names the project Bowtie_ATKx. It also creates an HFSS Driven Terminal design and predefines the solution settings, two sweeps, boundaries, excitations, and a set of various results.

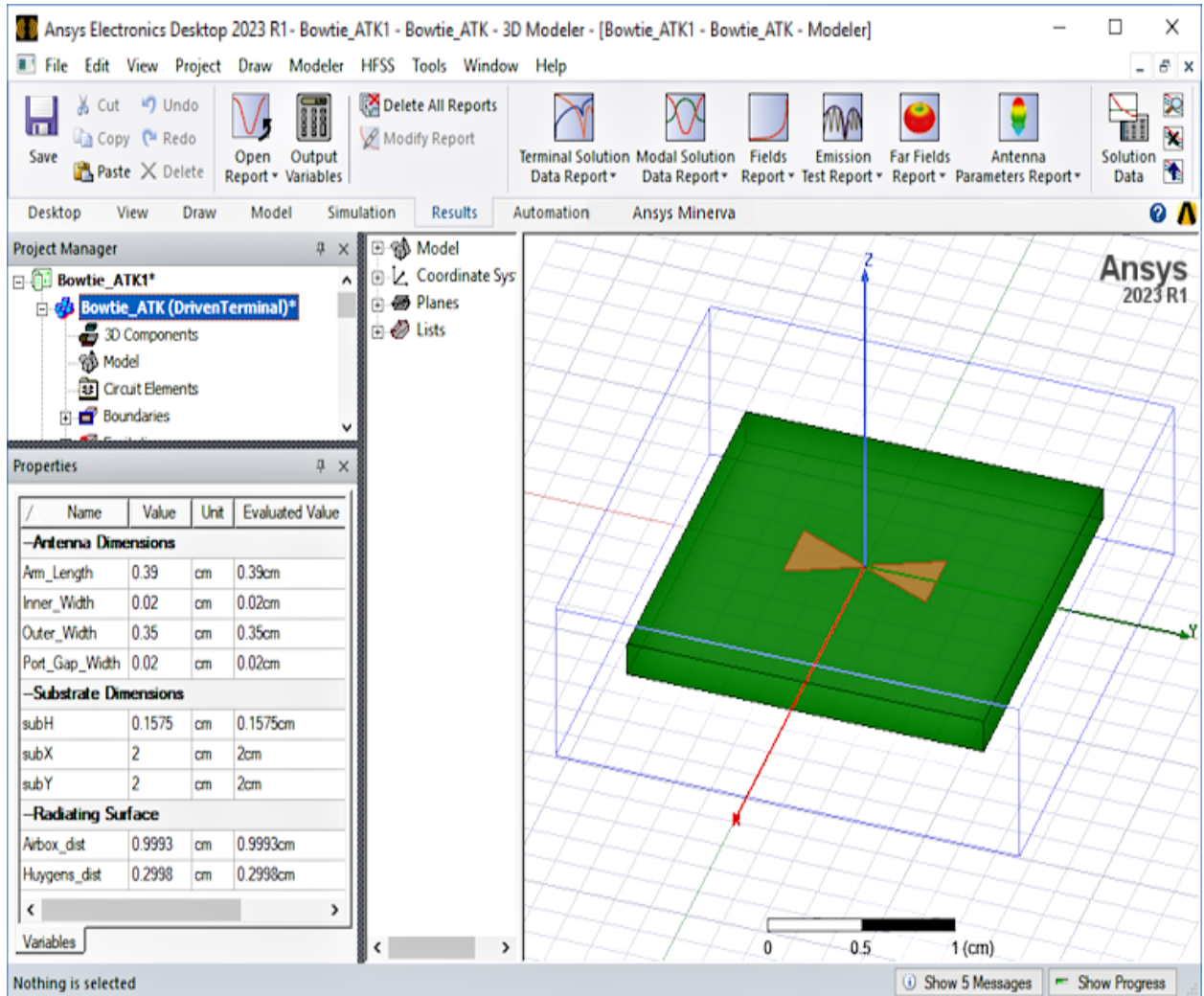

16. Under Analysis right-click **ATK_Solution** and select **Analyze** to start the simulation.
17. Once the simulation completes, you can double-click the plots under **Results** to view the far field gain, return loss, input impedance, and more. Three of the available reports are shown below:

Ansys Inc.

ff_3D_GainTotal

Ansys
2023 R1

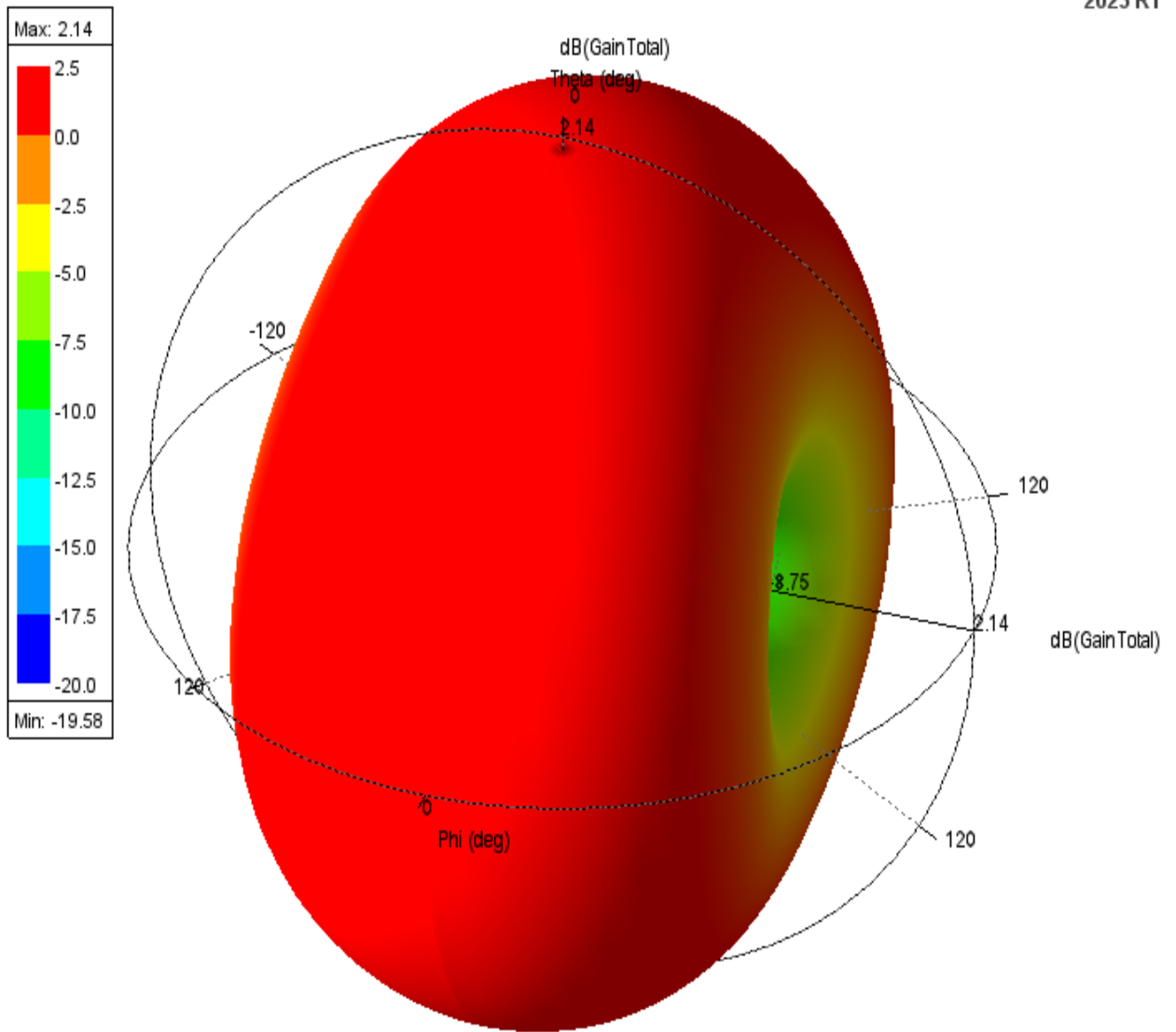

Return Loss

Bowtie ATK **Ansys**
2023 R1

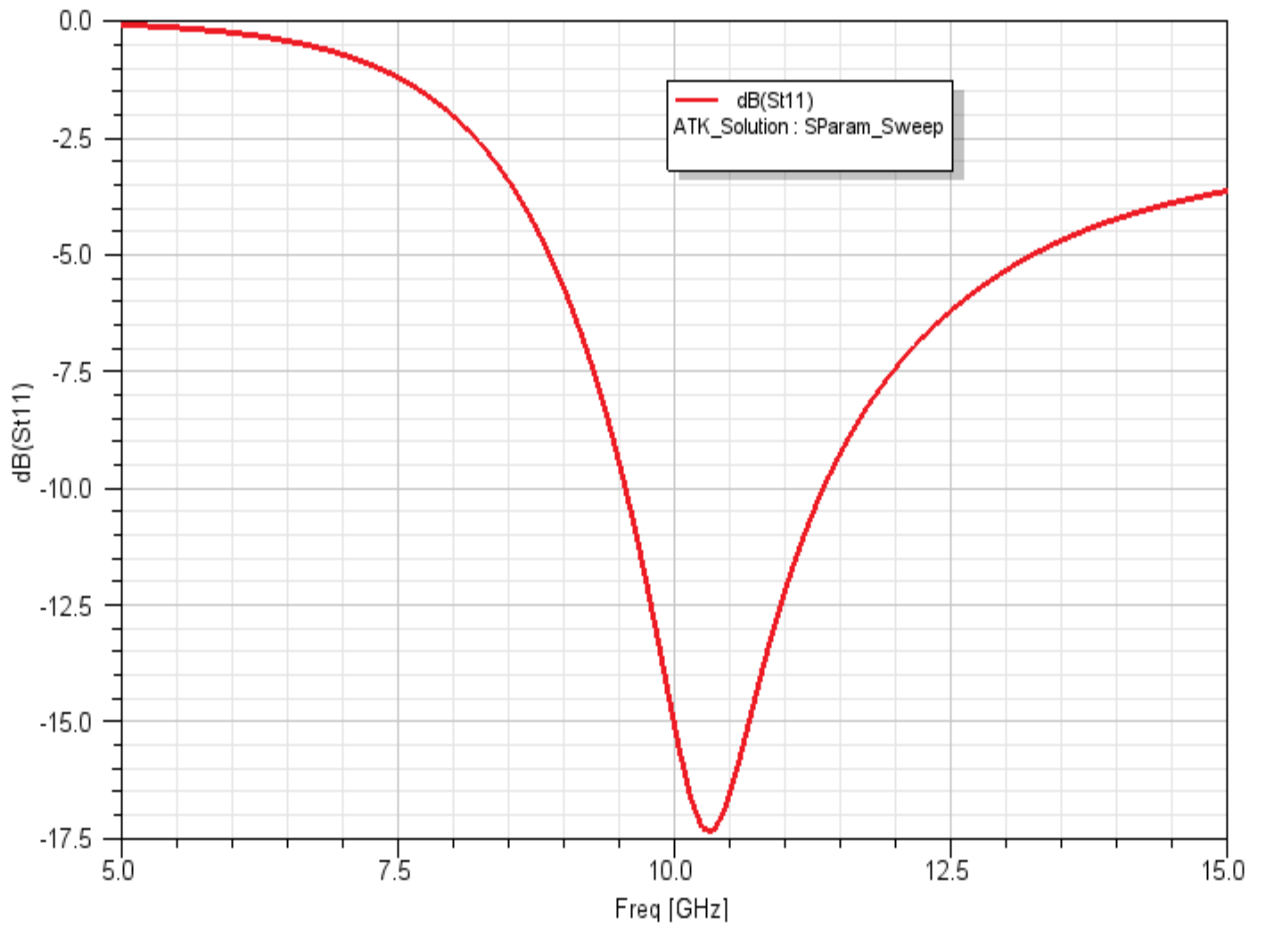

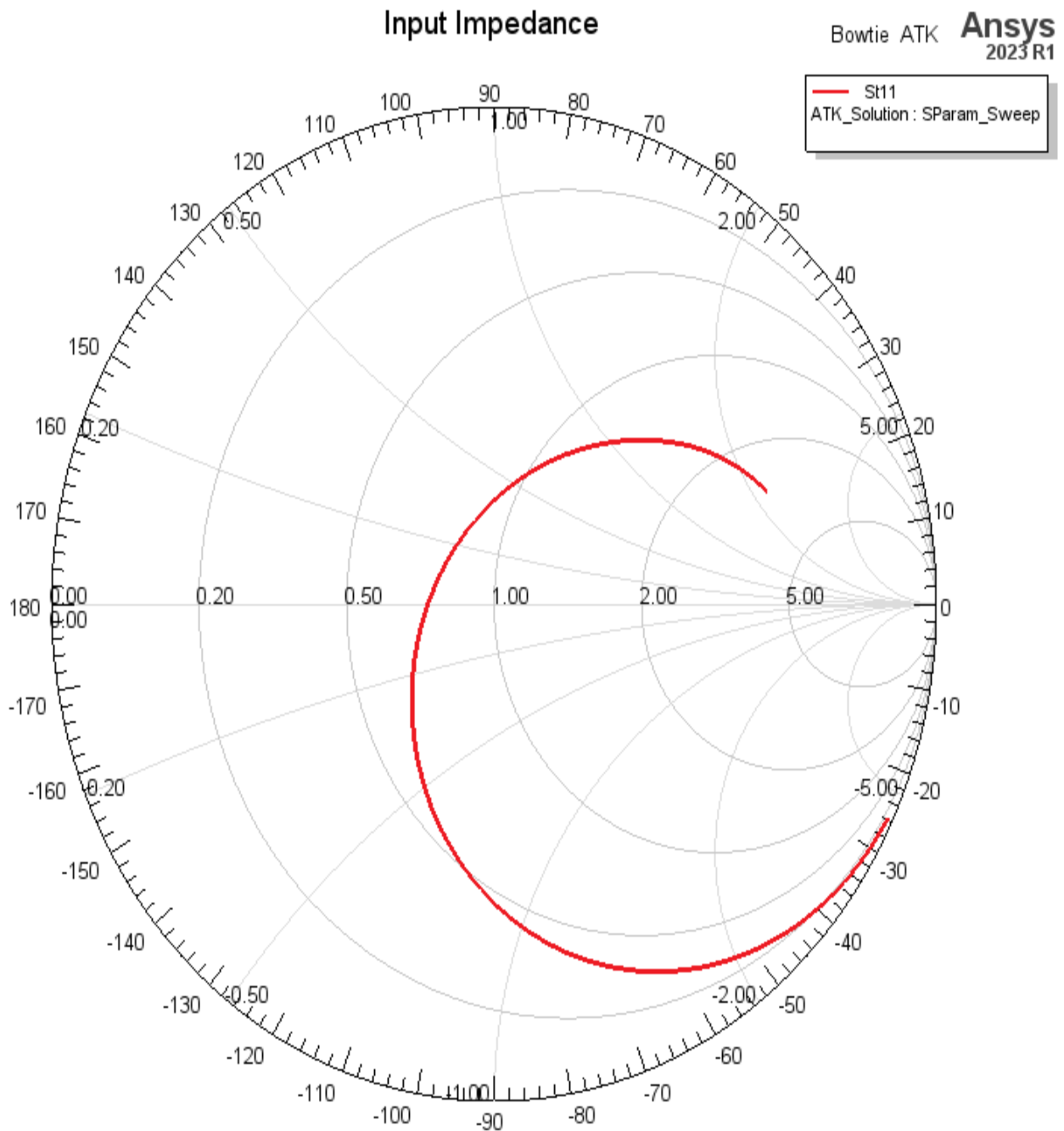

18. In the Project Manager, select the HFSS design, **Bowtie_ATK (DriverTerminal)**.

Notice that a list of design variables is displayed within the docked *Properties* window:

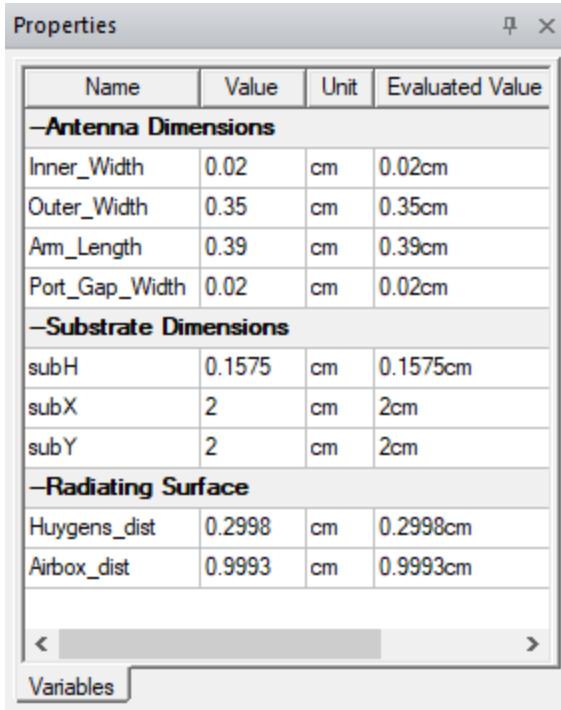

Name	Value	Unit	Evaluated Value
—Antenna Dimensions			
Inner_Width	0.02	cm	0.02cm
Outer_Width	0.35	cm	0.35cm
Arm_Length	0.39	cm	0.39cm
Port_Gap_Width	0.02	cm	0.02cm
—Substrate Dimensions			
subH	0.1575	cm	0.1575cm
subX	2	cm	2cm
subY	2	cm	2cm
—Radiating Surface			
Huygens_dist	0.2998	cm	0.2998cm
Airbox_dist	0.9993	cm	0.9993cm

< >

Variables

Note:

- The antenna toolkit (ATK) creates a parametric design. Therefore, you can easily adjust any of the variables that define the geometry and rerun the analysis to see the effects of the changes.
- While the wizard is still displayed (before generating the model), you can override any of the automatically determined variables. In that way, you can directly generate a customized antenna instead of a fully automatic one.
- The bow tie antenna generated by the wizard differs in three ways from the two antennas you modeled previously using the parametric and linear approaches:
 - Both of the prior bow tie antenna shapes are cutouts, material removed from the ground plane. You might consider them the negative or inverse version of a conventional antenna. The antenna area is non-conducting, and it is surrounded by a conducting ground plane. The HFSS Antenna Toolkit version is a conducting bow tie shape atop and surrounded by a non-conducting substrate.
 - The prior antennas had the port area offset from the centerline of the bow tie arms, whereas the antenna toolkit version places the excitation at the small inside edge of each bow tie arm (that is, at the exact center of the antenna). The result is that the latter design produces a perfectly symmetrical radiation pattern, as evidenced by the symmetrical 2D and 3D gain plots.
 - The toolkit design is much smaller than the prior two antennas.

The characteristics of the toolkit design are therefore significantly different from the antennas you built previously in this *Getting Started Guide*. Naturally, the design differences make the results of the manually built and toolkit antenna simulations significantly different.

This topic completes the *Getting Started with HFSS: Bow Tie Antenna* guide. You can save and close the ATK version of the bow tie and close the project.

6 - Optionally, Restore Current View Orientations

You have completed this getting started guide.

If you prefer to use the new view orientations implemented in version 2024 R1 of the Ansys Electronics Desktop application, clear the *Use Legacy View Orientation* option as follows:

1. From the menu bar, click **View > Options**.

The *3D UI Options* dialog box appears.

2. Ensure that **Enable Legacy View Orientation** is cleared:

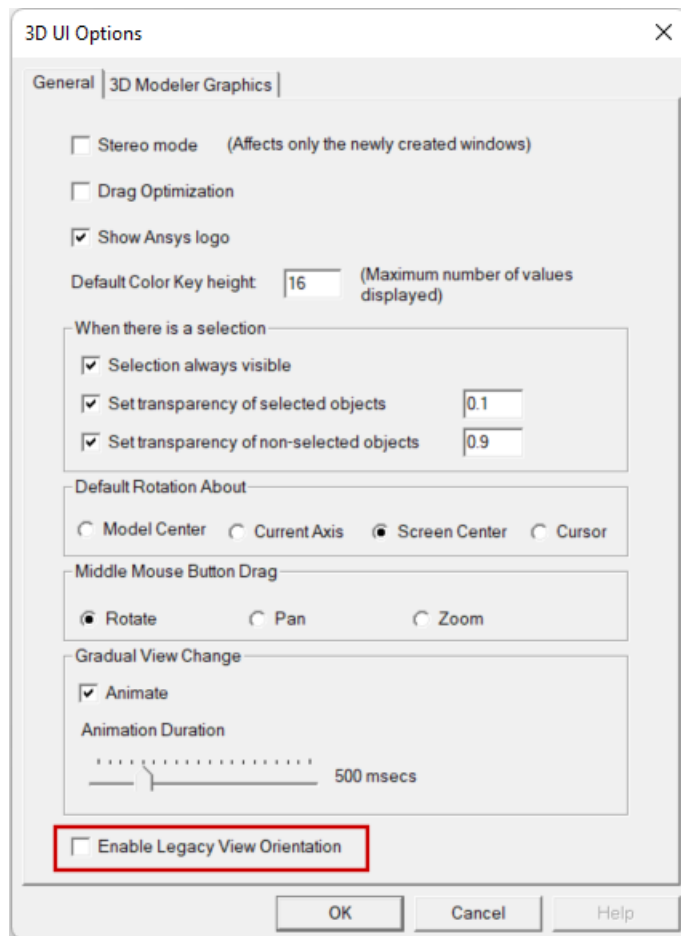

3. Click **OK**.

The settings in the 3D UI Options dialog box are global. Your choice is retained for all future program sessions, projects, and design types that use the 3D Modeler or that produce 3D plots of results.

You can now save and close this project.